



# Supplementary Catalogue

Issue 14



*The choice of perfection*

Worlds largest manufacturer of wash guns, lances, unloader valves, foam injection systems, couplings and much, much more. G&S Penrith Ltd are the sole authorised distributors for the UK & Ireland.



German manufacturer of quality stainless steel and powder coated hose reels.



Italian manufacturer of high pressure water pumps designed for various applications from pressure washers, misting, fire fighting, reverse osmosis and may more.



German manufacturer of stainless steel nozzles for spraying a wide variety of liquids.



Danish manufacturer of low pressure water couplings.



Italian manufacturer of complete boiler units and hot boxes



Manufacturer of high quality pumps for use in a wide variety of industries. Known for their longevity and reliability



Italian manufacturer of electric motors. Using only Grade A copper for the windings, Nicolini Motors have a reputation for being one of the best motors you can buy.



*Spraying Systems Limited*

Manufacturer of stainless steel nozzles. Used in a wide variety of industries, such as misting, pressure washing, foaming, dust suppression and many more



German manufacturer of high pressure triplex pumps and unloader valves





Welcome to the 14th edition of our Supplementary Catalogue.

This version contains those popular products from R+M Suttner, as well as products from some of the leading European manufacturers, such as those listed on the previous page.

We strive to sell the best quality products available, so have selected our Partners very carefully based on their product range and the quality, stockholding and backup that they provide. Most of the new products in this edition come from these manufacturers.

As always not everything we sell is listed in this catalogue. That's why we've also got our website:

[www.flowjet.co.uk](http://www.flowjet.co.uk)

Our website is also the place to go to, to view your prices, look at stock availability, as well as view technical data and watch our product demonstration and self help videos.

As always our team, here in Kendal, are available should you have any questions or if you're looking for something that you can't find.

01539 566193

[sales@flowjet.co.uk](mailto:sales@flowjet.co.uk)





**FLOWJET**  
Cleaning Equipment



# CATEGORIES



|             | CATEGORY                      | PAGES   |
|-------------|-------------------------------|---------|
| Yellow      | LOW PRESSURE EQUIPMENT        | 9-28    |
| Red         | HIGH PRESSURE EQUIPMENT       | 29-40   |
| Dark Red    | MOTORS & ELECTRICAL           | 41-43   |
| Light Green | HOSE ADAPTORS & CONNECTORS    | 45-55   |
| Green       | HIGH PRESSURE HOSES           | 57-67   |
| Dark Green  | SEWER CLEANING EQUIPMENT      | 69-75   |
| Magenta     | GUNS AND LANCES               | 77-90   |
| Light Blue  | NOZZLES & WASHING ACCESSORIES | 91-105  |
| Blue        | FOAM EQUIPMENT                | 107-120 |
| Cyan        | SITE & VEHICLE WASH EQUIPMENT | 121-130 |
| Purple      | BURNER EQUIPMENT & SPARES     | 131-138 |
| Yellow      | VACUUM CLEANER SPARES         | 139-144 |
| Grey        | CONSUMABLES                   | 145-147 |
|             | TECHNICAL & CONTACT INFO      | 149-153 |

## LOW PRESSURE EQUIPMENT

|                                   |    |                                 |    |
|-----------------------------------|----|---------------------------------|----|
| Food Grade Hoses                  | 10 | Misting & longcast Lances       | 20 |
| Hygiene Ultra Hoses               | 11 | Chemical & Suction Filters      | 21 |
| Suction & Delivery Hoses          | 12 | Inline Filter Bodies & Elements | 22 |
| Garden Hose & Geka Style Fittings | 13 | Micron Filters & Accessories    | 23 |
| NiTO Quick Release Couplings      | 14 | Check Valves & Float Valves     | 24 |
| NiTO Click & Stainless Series     | 15 | Tanks, Solenoid Valves & Gauges | 25 |
| Metal & Plastic Hosetails         | 16 | Vikan Brushes & Poles           | 26 |
| Hose Joiners & 150lb SS Fittings  | 17 | Suttner & ERIE Brushes & Poles  | 27 |
| Ball Valves & Metering Valves     | 18 | Hose Hangers & Descaling Fluid  | 28 |
| Wash Guns                         | 19 |                                 |    |

## HIGH PRESSURE EQUIPMENT

|                                 |    |                                 |    |
|---------------------------------|----|---------------------------------|----|
| Udor Pumps & Gearboxes          | 30 | Suttner & PA Unloader Valves    | 36 |
| Udor Pumps & Repair Kits        | 31 | Other Unloader Valves           | 37 |
| Interpump Pumps & Repair Kits   | 32 | Flow Switches & Solenoid Valves | 38 |
| CAT & Speck Pumps & Repair Kits | 33 | Pressure Switches & Gauges      | 39 |
| Karcher & Annovi Repair Kits    | 34 | Chemical Injectors & AV Mounts  | 40 |
| Hawk & Comet Repair Kits        | 35 |                                 |    |

## MOTORS & ELECTRICAL

|                               |    |
|-------------------------------|----|
| Nicolini Electric Meters      | 42 |
| Capacitors & Other Components | 43 |

## HOSE ADAPTORS & CONNECTORS

|                                |    |                                 |    |
|--------------------------------|----|---------------------------------|----|
| BSP Threaded Adaptors          | 46 | M22M & Gun Inlet Adaptors       | 51 |
| BSP Sockets & Elbows           | 47 | Mini & Midi Quick Couplings     | 52 |
| BSP T & Y Pieces, Plugs & Caps | 48 | TEMA, ST45 & ST3100 QRC's       | 53 |
| K-Lock & M22F Adaptors         | 49 | Inline & 90° Swivel Couplings   | 54 |
| Other Quick Screw Couplings    | 50 | Thread Sealants, Seals & Pastes | 55 |

## HIGH PRESSURE HOSES & FITTINGS

|                                 |    |                                 |    |
|---------------------------------|----|---------------------------------|----|
| Smooth Cover Hoses              | 58 | Loose Hose                      | 63 |
| Wrapped Cover Hoses             | 59 | Bend Restrictors                | 64 |
| Hoses to suit Karcher & Nilfisk | 60 | Ferrules                        | 65 |
| Hygiene Ultra 40                | 61 | BSP & M22F Hose Inserts         | 66 |
| Other Food Grade Hoses          | 62 | Other Hose Inserts & Protection | 67 |

## SEWER & DRAIN CLEANING

|                                  |    |
|----------------------------------|----|
| Standard Drain Cleaning Nozzles  | 70 |
| Male Thread, Silt & Turbo Heads  | 71 |
| Cylinder & Milling Style         | 72 |
| Hydro Excavation & Nozzle Spares | 73 |
| Drain & Sewer Hoses              | 74 |
| Foot Control Valves              | 75 |

## GUNS & LANCES

|                              |    |                                  |    |
|------------------------------|----|----------------------------------|----|
| Suttner Gun Range Info       | 78 | Lance Assemblies                 | 85 |
| 20 - 80 bar Suttner Guns     | 79 | Easyturn & ST85 Push-Pull Lances | 86 |
| 125 - 310 bar Suttner Guns   | 80 | Telescopic & Longcast Lances     | 87 |
| 310 - 600 bar Suttner Guns   | 81 | Twin Lances                      | 88 |
| Tecpro Gun & Lance Sets      | 82 | Lance Quick Release Connections  | 89 |
| HACCP Guns & Lances          | 83 | Foot Valves & Lance Holders      | 90 |
| Lance Pipes & Moulded Lances | 84 |                                  |    |

## NOZZLES & WASHING ACCESSORIES

|                                |    |                                   |     |
|--------------------------------|----|-----------------------------------|-----|
| Nozzle Selection Chart         | 92 | Nozzle Protectors                 | 99  |
| Spraying Systems Nozzles       | 93 | Adjustable Nozzle Holders         | 100 |
| 1/8", PMEG & VV Nozzles        | 94 | Wash Brushes                      | 101 |
| Lechler, Vario & Steam Nozzles | 95 | Rotary Floor Cleaners             | 102 |
| Turbo Nozzles                  | 96 | Rotary Wall & ST97 Floor Cleaners | 103 |
| Hydroblade & Dust Suppression  | 97 | Sand Blasters & Mud Suckers       | 104 |
| Quick Release Nozzles          | 98 | Tank Cleaning Nozzles             | 105 |

## FOAM EQUIPMENT & ACCESSORIES

|                                |     |                             |     |
|--------------------------------|-----|-----------------------------|-----|
| ST73 Snow Foam Lances          | 108 | Foam Injector Spares        | 115 |
| LS3 & Snow Foam Adaptors       | 109 | ST72 & ST75 Foam Lances     | 116 |
| Foam Nozzle Chart              | 110 | ST76, ST175 & ST75.2 Lances | 117 |
| ST160 Foam Injectors           | 111 | Foam Guns & Nozzles         | 118 |
| ST164 Twin Foam Injectors      | 112 | Other Chemical Injectors    | 119 |
| ST167 Full Flow Foam Injectors | 113 | Tank Sprayers & Foamers     | 120 |
| ST168 Full Flow Foam Inj + Air | 114 |                             |     |

## SITE & VEHICLE WASH EQUIPMENT

|                                    |     |                               |     |
|------------------------------------|-----|-------------------------------|-----|
| TEHA Hose Reels                    | 122 | Vehicle Wash Booms            | 127 |
| TEHA Reel Swivel Brackets          | 123 | Coin & Token Meters           | 128 |
| Ecodora Stainless Hose Reels       | 124 | Marolex Pump Up Sprayers      | 129 |
| Stainless Steel Hose Reel Trolleys | 125 | Compression Fittings & Clamps | 130 |
| Lance & Brush Holders              | 126 |                               |     |

## BURNER EQUIPMENT & SPARES

|                               |     |
|-------------------------------|-----|
| Replacement Heating Coils     | 132 |
| Mazzoni Hot Boxes & Coils     | 133 |
| Ignition Electrodes           | 134 |
| Burner Nozzles & Fuel Filters | 135 |
| Fuel Pumps                    | 136 |
| Ignition Transformers         | 137 |
| Burner Motors & Thermostats   | 138 |

## VAC SPARES & ACCESSORIES

|                                |     |
|--------------------------------|-----|
| Vacuum Motors                  | 140 |
| Vacuum Hose & Connectors       | 141 |
| Vacuum Crevice Tools & Brushes | 142 |
| Floor Tools & Antistatic       | 143 |
| Vac Boom & Car Wash            | 144 |

## CONSUMABLES

|                            |     |
|----------------------------|-----|
| Self Centring Bonded Seals | 146 |
| Hose Clips & Clamps        | 146 |
| Tools                      | 146 |
| O'Ring Sets                | 147 |
| Cable Ties                 | 147 |
| Compartment Boxes          | 147 |





# LOW PRESSURE EQUIPMENT

|                                     |    |
|-------------------------------------|----|
| Food Grade Hoses                    | 10 |
| Hygiene Ultra Hoses                 | 11 |
| Suction & Delivery Hoses            | 12 |
| Garden Hose & Geka Style Fittings   | 13 |
| NiTO Quick Release Couplings        | 14 |
| NiTO Click & Stainless Series       | 15 |
| Metal & Plastic Hosetails           | 16 |
| Hose Joiners & 150lb SS Fittings    | 17 |
| Ball & Metering Valves              | 18 |
| Wash Guns                           | 19 |
| Misting & Longcast Lances & Nozzles | 20 |
| Chemical & Suction Filters          | 21 |
| Inline Filter Bodies & Elements     | 22 |
| Micron Filters & Accessories        | 23 |
| Check & WRAS Approved Float Valves  | 24 |
| Tanks, Solenoid Valves & Gauges     | 25 |
| Vikan & Mr Longarm Brushes & Poles  | 26 |
| Suttner & Erie Brushes & Poles      | 27 |
| Hose Hangers & Descaling            | 28 |

Food Grade Cleaning Hoses



| Foodjet Hose  |              | Blufood Hose   |             | PUREclean 365+ 40 Hose   |             | PUREclean 365+ 100 Hose   |              |
|---|--------------|--|-------------|--|-------------|---|--------------|
| Foodjet hose is a 12mm ID cleaning hose designed for the food industry according to EN854, and is particularly resistant to animal and poultry fats. Suitable for 50% chemical solutions. Smooth, anti abrasion rubber cover with a textile braid and synthetic interior lining |              | Blufood hose has been designed for use with industrial foam applications, according to 2007/19/EC, 2002/72/EC and 10/2011 regulations. Suitable for contact with liquid food products. Smooth covered, 5 layered PVC hose with textile braid |             | Industrial foam application hose according to (EC)2002/72, 10/2011, (EG)1935/2004 and 2023/2006 for use within the food industry. Suitable for contact with liquid food products. Smooth cover, 3 layered hose with rot proof textile braid. |             | Industrial foam application hose according to (EC)2002/72, 10/2011, (EG)1935/2004 and 2023/2006 for use within the food industry. Suitable for contact with liquid food products. Smooth cover, 3 layered hose with rot proof textile braid. Approx 20% lighter than similar hose types |              |
| Size  | DN12         | DN12   | DN12        | DN12   | DN12        | DN12  | DN12         |
| Rating  | 80bar, 150°C | 50bar, 70°C  | 50bar, 70°C | 45bar, 70°C  | 45bar, 70°C | 18bar, 100°C  | 18bar, 100°C |
| Weight  | 210g/m       | 320g/m   | 320g/m      | 250g/m   | 250g/m      | 250g/m  | 250g/m       |
| Part No   | 30360        | 30370  | 30370       | 30366040   | 30366040    | 3066100   | 3066100      |

For hoses complete with bend restrictors and stainless steel ends, please see page 62

Tricoflex Thermoclean AL20 Hose



Thermoclean AL20 is a medium pressure hose suitable for hot water cleaning applications within the food processing industry. It has a blue non staining outer cover, a special intermediate adhesive layer and a white inner layer with high temperature performance. Available in either 12mm or 19mm ID's and in 50m coils. Complies with (EU) No10/2011

| Size    | 12mm        | 19mm        |
|---------|-------------|-------------|
| Rating  | 20bar, 70°C | 20bar, 70°C |
| Part No | GSAL2012    | GSAL2019    |

Tricoflex Hose



The iconic yellow watering hose. Made from an exclusive woven fibre and a double care layer, ensures that Tricoflex is highly flexible for easy handling, with excellent resistance to repeated bending, crushing and pulling as well as minor deformation under pressure.

In addition, the lining is extremely smooth, thereby maintaining even flow. Especially thick and made of high quality materials, Tricoflex offers remarkable aging resistance and exceptional preservation of flexibility. It's exterior yellow PVC covering gives good protection against abrasion and UV damage.

| ID   | Ø      | 25m       | 50m       | 100m       |
|------|--------|-----------|-----------|------------|
| 12mm | 18mm   | TRICO1225 | TRICO1250 | TRICO12100 |
| 19mm | 25.5mm | TRICO1925 | TRICO1950 | TRICO19100 |
| 25mm | 32.5mm | TRICO2525 | TRICO2550 |            |

## LOW PRESSURE EQUIPMENT

### HYGIENE ULTRA 40 with Antimicrobial Cover

**'Antimicrobial' is an agent that kills micro-organisms or inhibits their growth.**

Our **exclusive** HYGIENE ULTRA 40 hose comes with antimicrobial impregnated cover which stops micro-organisms, such as bacteria, from growing on it's surface. The 40 bar rated hose is available with a 12mm internal bore, with either a red or blue smooth cover. Designed specifically for the food processing industry, this hose is the perfect fit for all foaming & rinsing applications. HACCP Compliant

This hose is available in loose lengths, or we can make hoses to your exact specifications with stainless steel ends and food grade bend restrictors as standard.

Rating: 40bar, 70°C



| ID   | Ø    | Blue Cover | Red Cover | Yellow Cover | Green Cover |
|------|------|------------|-----------|--------------|-------------|
| 12mm | 22mm | HYG40B     | HYG40R    | HYG40Y       | HYG40G      |

*Available in loose lengths, or as an assembly to suit your specific requirements*

### Assembled HYGIENE ULTRA 40 Hoses



|     | 1/2" F  | 1/2" M/F | 1/2" M  |
|-----|---------|----------|---------|
| 10m | HUB10FF | HUB10MF  | HUB10MM |
| 15m | HUB15FF | HUB15MF  | HUB15MM |
| 20m | HUB20FF | HUB20MF  | HUB20MM |
| 25m | HUB25FF | HUB25MF  | HUB25MM |
| 30m | HUB30FF | HUB30MF  | HUB30MM |

|     | 1/2" F  | 1/2" M/F | 1/2" M  |
|-----|---------|----------|---------|
| 10m | HUR10FF | HUR10MF  | HUR10MM |
| 15m | HUR15FF | HUR15MF  | HUR15MM |
| 20m | HUR20FF | HUR20MF  | HUR20MM |
| 25m | HUR25FF | HUR25MF  | HUR25MM |
| 30m | HUR30FF | HUR30MF  | HUR30MM |



|     | 1/2" F  | 1/2" M/F | 1/2" M  |
|-----|---------|----------|---------|
| 10m | HUY10FF | HUY10MF  | HUY10MM |
| 15m | HUY15FF | HUY15MF  | HUY15MM |
| 20m | HUY20FF | HUY20MF  | HUY20MM |
| 25m | HUY25FF | HUY25MF  | HUY25MM |
| 30m | HUY30FF | HUY30MF  | HUY30MM |

|     | 1/2" F  | 1/2" M/F | 1/2" M  |
|-----|---------|----------|---------|
| 10m | HUG10FF | HUG10FF  | HUG10FF |
| 15m | HUG15FF | HUG15FF  | HUG15FF |
| 20m | HUG20FF | HUG20FF  | HUG20FF |
| 25m | HUG25FF | HUG25FF  | HUG25FF |
| 30m | HUG30FF | HUG30FF  | HUG30FF |

## LOW PRESSURE EQUIPMENT

### Clear & Reinforced PVC Hose



| ID   |       | Clear PVC. Ideal for transfer of chemicals. Max 60°C<br>Sold in 30m coils |       | Clear Braided PVC<br>Max 60°C<br>Sold in 30m coils | Blue Braided PVC<br>Max 60°C<br>Sold in 5m multiples | Yellow Braided PVC<br>Max 60°C<br>Sold in 5m multiples |
|------|-------|---|-------|--|--|--|
| 4mm  | 1mm   | 30610   |       |  |  |  |
| 6mm  | 1.5mm | 30620   | 3mm   | 30640  |  |  |
| 8mm  | 2mm   | 30630   | 3mm   | 30650  | TPCRISTAL8B  |  |
| 9mm  |       |   | 3mm   |  | 080000310  | 080000320  |
| 10mm |       |   | 3mm   | 30660  |  |  |
| 13mm |       |   | 3.5mm | 30670  |  |  |
| 16mm |       |   | 3mm   | 30680  |  |  |
| 19mm |       |   | 3.5mm | 30690  |  |  |

### Rubber Multipurpose Hoses



| ID   |       | Technobel Rubber Fuel Hose<br>Max 20bar, 60°C<br>Sold in 50m Coils | Black Rubber Hose<br>Max 20bar, 60°C<br>Sold in multiples of 5m | Hose Scissors |
|------|-------|--|---|---------------|
| 6mm  | 2.5mm | TECHNOBEL6/50  |   | 95500         |
| 13mm | 4mm   |  | 30510   |               |
| 19mm | 5mm   |  | 30520   |               |
| 25mm | 5mm   |  | 30530   |               |

### Multipurpose Suction & Delivery Hoses



| ID |       | Flexible Transparent Hose with Metal Spiral<br>Max 40°C<br>Sold in 5m multiples. Coil length 30m |       | Green Spiral Line Translucent Hose<br>Max 50°C<br>Sold in 5m multiples. Coil length 25m |
|----|-------|--|-------|---|
| 13 | 2.5mm | LPH010   |       |   |
| 19 | 3.5mm | LPH015   | 2.6mm | 307519  |
| 25 | 4mm   | LPH020   | 2.7mm | 307525  |
| 32 | 4mm   | LPH025   | 2.7mm | 307532  |
| 38 | 4mm   | LPH030   | 2.7mm | 307538  |
| 50 | 5.5mm | LPH035   | 4mm   | 307550  |

## LOW PRESSURE EQUIPMENT

### Universal Quick Release Probes & Couplings



| Thread | Brass Probe Female Thread | Plastic Probe Female Thread | Brass Probe Male Thread | Hose ID | Brass Coupling | Plastic Coupling | Brass Coupling + NRV | Plastic Coupling + NRV |
|--------|---------------------------|-----------------------------|-------------------------|---------|----------------|------------------|----------------------|------------------------|
| 1/2"   | 728310                    | 72700                       | 728320                  | 12mm    | 728330         | 72701            | 728335               | 72741                  |
| 3/4"   | 728311                    | 72710                       | 728321                  | 19mm    | 728331         | 72703            |                      |                        |
| 1"     | 728312                    | 72713                       |                         |         |                |                  |                      |                        |

### Other Universal Quick Release Couplings & Probes



| Brass Coupling x 3/4\"/> |        |       |        |         |        |
|--------------------------|--------|-------|--------|---------|--------|
| 728334                   | 728333 | 72745 | 728340 | 7284654 | TPLP90 |

### Geka Style Bayonet Claw Couplings



| Size | With Hosetail | With Swivel Hosetail | Leak Proof Twist Sleeve | Size | Male Thread | Female Thread |
|------|---------------|----------------------|-------------------------|------|-------------|---------------|
| 10mm | 72005         |                      |                         | 3/8" | 72310       | 72210         |
| 13mm | 72010         |                      |                         | 1/2" | 72320       | 72220         |
| 19mm | 72020         | 720204               | 72415                   | 3/4" | 72330       | 72230         |
| 25mm | 72030         |                      |                         | 1"   | 72340       | 72240         |



| 3 Way Adaptor | 3/4\"/> |       |       |      |       |
|---------------|---------|-------|-------|------|-------|
| 72500         | 72505   | 72510 | 72520 | 1/2" | 72524 |
|               |         |       |       | 3/4" | 72525 |
|               |         |       |       | 1"   | 72526 |

NiTO Series Couplings



\* made by Suttner \* made by Suttner \* made by Suttner

| NiTO Series   | Coupling with 12mm Hosetail | Coupling with 19mm Hosetail | Coupling with 1/2" F Thread | Coupling with 3/4" F Thread | Coupling with 1" F Thread | Coupling with 3/4" M Thread | Coupling with 1" M Thread | Coupling O' Ring |
|---------------|-----------------------------|-----------------------------|-----------------------------|-----------------------------|---------------------------|-----------------------------|---------------------------|------------------|
| 5 Series 1/2" | 5350s                       | 5351s                       | 5350                        | 5352                        |                           |                             |                           | 5347             |
| 6 Series 3/4" |                             | 6350s                       |                             | 6350                        | 200045230*                | 200045240*                  | 200045250*                | 6347             |
| 7 Series 1"   |                             |                             |                             |                             | 7350                      |                             |                           | 7347             |
| Flat Washer   |                             |                             | 53440A8                     | 63440A8                     | 73440A8                   |                             |                           |                  |

NiTO Series Probes with Hosetails



| NiTO Series   | Probe Ø | Probe with 6mm Hosetail | Probe with 10mm Hosetail | Probe with 12mm Hosetail | Probe with 12-19mm HT | Probe with 19mm Hosetail | Probe with 19-25mm HT | Probe with 25mm Hosetail |
|---------------|---------|-------------------------|--------------------------|--------------------------|-----------------------|--------------------------|-----------------------|--------------------------|
| 5 Series 1/2" | 15.7mm  | 6360D                   | 5360B                    | 5360                     | 5360A                 |                          |                       |                          |
| 6 Series 3/4" | 19.4mm  |                         |                          | 6360B                    | 6360s                 | 6360                     | 6360A                 |                          |
| 7 Series 1"   | 25.7mm  |                         |                          |                          |                       | 7360B                    |                       | 7360                     |

NiTO Series Probes with BSP Threads



| NiTO Series   | 3/8" F Probe | 1/2" F Probe | 3/4" F Probe | 1" F Probe | 3/8" M Probe | 1/2" M Probe | 3/4" M Probe | 1" M Probe |
|---------------|--------------|--------------|--------------|------------|--------------|--------------|--------------|------------|
| 5 Series 1/2" | 5361B        | 5361         | 5361A        |            | 5364B        | 53640A3      | 5364AA3      |            |
| 6 Series 3/4" |              | 6361A        | 63610A3      |            |              | 6364A        | 6364         |            |
| 7 Series 1"   |              |              |              | 7361       |              |              |              | 7364       |

## LOW PRESSURE EQUIPMENT

### NiTO Series Accessories

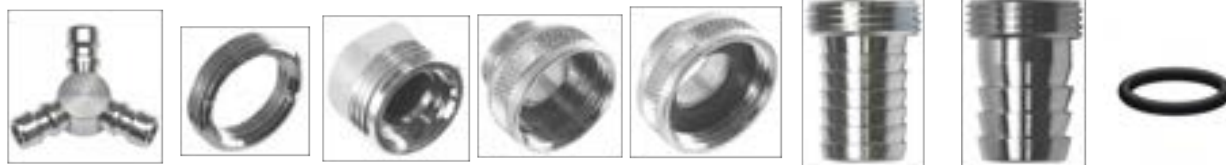

| NiTO Series   | 3 Way Adaptor | 1/2" F x 3/4" M Ring Bush | 1/2" F x 3/4" M Extension Bush | 1/2" M x 3/4" F Reducer | 3/4" M x 1" F Reducer | 3/4" M x 19mm Hosetail | 1" M x 25mm Hosetail | Coupling O Ring |
|---------------|---------------|---------------------------|--------------------------------|-------------------------|-----------------------|------------------------|----------------------|-----------------|
| 5 Series 1/2" | 5376          | 53490A8                   | 5371A                          | 5369                    |                       |                        |                      | 5347            |
| 6 Series 3/4" |               |                           |                                |                         | 6369                  | 6367                   |                      | 6347            |
| 7 Series 1"   |               |                           |                                |                         |                       |                        | 7367                 | 7347            |

### NiTO CLICK Series

Compatible with standard garden style quick release systems from manufacturers such as Hozelock, Gardena & many more



| Inlet           | Coupling | Coupling x Hosetail | Coupling, Hosetail + NRV | Female Threaded Probe | Male Threaded Probe | Probe x HT |
|-----------------|----------|---------------------|--------------------------|-----------------------|---------------------|------------|
| 1/2"            | 5950NA3  |                     |                          |                       | 59640A3             |            |
| 3/4"            |          |                     |                          |                       | 5964AA3             |            |
| 1/2" F & 3/4" F | 5952GA3  |                     |                          | 5961GA3               |                     |            |
| 12mm HT         |          | 5950SA3             | 5953SA3                  |                       |                     | 59600A3    |
| 12 - 19mm HT    |          |                     |                          |                       |                     | 5960AA3    |
| 19mm HT         |          | 5951SA3             |                          |                       |                     |            |

### NiTO CLICK MAXI Series



| Inlet   | Maxi Coupling | Maxi Probe |
|---------|---------------|------------|
| 3/4" M  |               | 69640A3    |
| 3/4" F  | 69500A3       | 69610A3    |
| 12mm HT |               | 6960BA3    |
| 19mm HT | 6950SA3       | 69600A3    |

### NiTO Stainless Steel Coupling System

Suitable for the food, pharmaceutical and engineering industries. Compatible with standard NiTO 5 & 6 Series couplings and probes



| NiTO Series | Coupling x 1/2" F | Coupling x 3/4" F | Coupling with 12mm HT | Probe x 12mm HT | Probe x 19mm HT | 3/4" M x 1/2" F Ring Bush |
|-------------|-------------------|-------------------|-----------------------|-----------------|-----------------|---------------------------|
| 5 Series    | 54500A3           |                   | 5450SA3               | 54600A3         |                 | 54490A3                   |
| 6 Series    |                   | 64500A3           |                       |                 | 64600A3         |                           |

## LOW PRESSURE EQUIPMENT

### Metal Hosetails



| Hose ID Ø (mm) | Thread | Brass Male Thread | Brass Taper Male Thread | Stainless Steel Taper Thread | Brass Fixed Female | Brass Female Swivel Nut |
|----------------|--------|-------------------|-------------------------|------------------------------|--------------------|-------------------------|
| 4              | 1/8"   |                   | GSBT1818                |                              |                    |                         |
| 6              | 1/8"   | 71000             |                         |                              |                    |                         |
| 6              | 1/4"   | 71010             | GSBT1414                | GS015                        | 710104             | GS860                   |
| 6              | 3/8"   |                   | GSBT3814                |                              |                    |                         |
| 6              | 1/2"   |                   | GSBT1214                |                              |                    |                         |
| 8              | 1/8"   | 71005             |                         |                              |                    |                         |
| 8              | 1/4"   | 71020             |                         |                              | 710204             |                         |
| 8              | 3/8"   | 71050             |                         |                              |                    |                         |
| 10             | 1/4"   |                   | GSBT1438                | GS015-10                     |                    | GS870                   |
| 10             | 3/8"   |                   | GSBT3838                | GS016                        |                    |                         |
| 10             | 1/2"   |                   | GSBT1238                |                              |                    |                         |
| 12             | 1/4"   | 71030             | GSBT1412                |                              |                    |                         |
| 12             | 3/8"   | 71060             | GSBT3812                | GS016-12                     | 710604             | GS895                   |
| 12             | 1/2"   | 71080             | GSBT1212                | GS017                        | 710804             | GS905                   |
| 12             | 3/4"   | 71090             | GSBT3412                |                              |                    |                         |
| 19             | 1/2"   |                   | GSBT1234                | GS017-19                     |                    |                         |
| 19             | 3/4"   | 71100             | GSBT3434                | GS018                        |                    | GS915                   |
| 19             | 1"     | 71120             | GSBT1034                |                              |                    |                         |
| 25             | 3/4"   |                   | GSBT3410                |                              |                    |                         |
| 25             | 1"     | 71110             | GSBT1010                |                              |                    |                         |

### Other Threaded Hosetails



| Hose ID Ø | Thread | Plastic Taper Male | Plastic Female Nut | Male 90° Elbow | Brass F + Lugs | Brass 90° + Lugs | Plastic 90° + Lugs |
|-----------|--------|--------------------|--------------------|----------------|----------------|------------------|--------------------|
| 6mm       | 1/4"   | 71220              | GS1270             | 71320          |                |                  |                    |
| 6         | 3/8"   | 71240              |                    |                |                |                  |                    |
| 10        | 3/8"   |                    | GS1280             |                |                |                  |                    |
| 10        | 1/2"   |                    | GS1290             |                |                | 71168            |                    |
| 12        | 3/8"   | 71260              |                    | 71360          |                |                  |                    |
| 12        | 1/2"   | 71280              | GS1295             | 71380          | 71152          |                  |                    |
| 12        | 3/4"   | GS1255             | GS1305             |                | 71150          | 71170            | 71160              |
| 19        | 1/2"   | GS1245             |                    |                |                |                  |                    |
| 19        | 3/4"   |                    | GS1310             | GS1680         | 71155          |                  |                    |



## LOW PRESSURE EQUIPMENT

### Hose Joiners



| Hose ID Ø | Brass Straight | Brass 'T' | Plastic Straight | Plastic 'T'             | Plastic 'Y' |
|-----------|----------------|-----------|------------------|-------------------------|-------------|
| 4mm       | GS960          |           |                  |                         |             |
| 6mm       | GS965          | GS995     | 71510            | 71710                   | 71610       |
| 8mm       | GS970          |           | 71520            |                         |             |
| 12mm      | GS980          |           |                  | GS1410*                 | 71630       |
| 19mm      | GS985          |           |                  | GS1420*                 |             |
| 25mm      | GS990          |           |                  | * Food Grade Blue Nylon |             |

### 150lb 316 Stainless Steel Fittings

A range of high Grade 316 stainless steel fittings suitable for a wide range of applications, especially those that use chemicals. Max 10bar



| Inlet | Outlet        | BSP Taper Hex Nipple | Barrel Nipple | Reducing Bush | Socket  | Union   |
|-------|---------------|----------------------|---------------|---------------|---------|---------|
|       | <b>Rating</b> | 10 bar               | 10 bar        | 10 bar        | 10 bar  | 10 bar  |
| 1/4"  | 1/4"          | ADP0005              | ADP0020       |               | ADP0060 | ADP0050 |
| 1/4"  | 3/8"          | ADP0006              |               | ADP0030       |         |         |
| 1/4"  | 1/2"          | ADP0007              |               | ADP0031       |         |         |
| 3/8"  | 3/8"          | ADP0008              | ADP0021       |               | ADP0061 | ADP0051 |
| 3/8"  | 1/2"          | ADP0009              |               | ADP0032       |         |         |
| 3/8"  | 3/4"          | ADP0010              |               | ADP0033       |         |         |
| 1/2"  | 1/2"          | ADP0011              | ADP0022       |               | ADP0062 | ADP0052 |
| 1/2"  | 3/4"          | ADP0012              |               | ADP0034       |         |         |
| 1/2"  | 1"            | ADP0013              |               | ADP0035       |         |         |
| 3/4"  | 3/4"          | ADP0014              | ADP0023       |               | ADP0063 | ADP0053 |
| 3/4"  | 1"            | ADP0015              |               | ADP0036       |         |         |
| 1"    | 1"            | ADP0016              | ADP0024       |               | ADP0064 | ADP0054 |



| Inlet | Outlet        | F/F Elbow | M/F Elbow | Female Tee | Taper Plugs |
|-------|---------------|-----------|-----------|------------|-------------|
|       | <b>Rating</b> | 10 bar    | 10 bar    | 10 bar     | 10 bar      |
| 1/4"  | 1/4"          | ADP0070   | ADP0080   | ADP0090    | ADP0100     |
| 3/8"  | 3/8"          | ADP0071   | ADP0081   | ADP0091    | ADP0101     |
| 1/2"  | 1/2"          | ADP0072   | ADP0082   | ADP0092    | ADP0102     |
| 3/4"  | 3/4"          | ADP0073   | ADP0083   | ADP0093    | ADP0103     |
| 1"    | 1"            | ADP0074   | ADP0084   | ADP0094    | ADP0104     |

## LOW PRESSURE EQUIPMENT

### Ball Valves



| Thread | Female Plated 'T' Handle. | Male/Female Plated 'T' Handle | Male/Female Long Handle | Male/Female Mini | WRAS Approved Brass Full Bore Ball Valve | ATEX Approved 2 Piece Stainless Ball Valve |
|--------|---------------------------|-------------------------------|-------------------------|------------------|--|--|
| Rating | 30-50bar, 90°C            | 30-50bar, 90°C                | 30-50 bar, 90°C         | 15bar, 90°C      | 32bar, 110°C                             | 82bar, 200°C                               |
| 1/4"   | GS1425                    | GS1445                        | GS1465                  | GS1600           | 70510                                    | LBV14SS                                    |
| 3/8"F  | GS1430                    | GS1450                        | GS1470                  |                  | 70520                                    | LBV38SS                                    |
| 1/2"F  | GS1435                    | GS1455                        | GS1475                  |                  | 70530                                    | LBV12SS                                    |
| 3/4"F  | GS1440                    | GS1460                        | GS1480                  |                  | 70540                                    | LBV34SS                                    |
| 1"F    |                           |                               |                         |                  | 70550                                    | LBV1SS                                     |

### Suttner Chemical Metering Valves



|        | ST161 Stainless Steel | ST66 Black | ST66 Red  | ST66 No Dial | ST61 Brass | ST61 Stainless |
|--------|-----------------------|------------|-----------|--------------|------------|----------------|
| 6mm HT |                       | 200066500  | 200066501 | 200066515    | ST61A      | ST61AS         |
| 9mm HT | 200161510             |            |           |              |            |                |

### Other Metering Valves



|        | Inline Chemical Check Valve | PA Inline Chemical Valve | PA Inline Chemical Valve, Dial & Viton Seals | PA 90° Chemical Valve | PA Steam Valve | Spindle Valve |
|--------|-----------------------------|--------------------------|--|-----------------------|----------------|---------------|
| 6mm HT | GSCVP                       | GS29094500               | GS29098000                                   | GS290954              |                |               |
| 1/4"F  |                             |                          |  |                       |                | 53510         |
| 1/4"M  |                             |                          |  |                       | GS29092012     |               |

## LOW PRESSURE EQUIPMENT

### Chemical Resistant Inline Guns & Lances

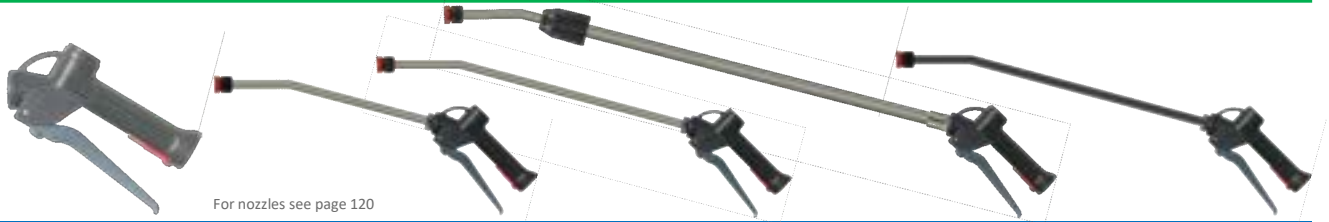

For nozzles see page 120

|        | Chemical Gun 1/2" F | Chemical Gun + 300mm SS Lance<br>(Nozzle not included) | Chemical Gun + 600mm SS Lance<br>(Nozzle not included) | Chemical Gun + 1000-2000mm Telescopic SS Lance<br>(Nozzle not included) | Chemical Gun + 600mm Plastic Lance<br>(Nozzle not included) |
|--------|---------------------|--|--|---|---|
| Spec   | 25bar, 70lpm, 50°C  | 25bar, 30lpm, 50°C                                     | 25bar, 30lpm, 50°C                                     | 25bar, 30lpm, 50°C  | 25bar, 30lpm, 50°C  |
| 1/2" F | 200510500           | 200510560  | 200510550  | 200510600   | 200510700   |

### Rubber Encased Wash Guns



| Inlet  | Princess Brass | Princess Stainless | Blue King   | Baby Blue   |
|--------|----------------|--------------------|-------------|-------------|
| Rating | 25bar, 95°C    | 25bar, 95°C        | 30bar, 95°C | 12bar, 95°C |
| 1/2" F | TEC010         | TEC011             | TEC012      | TEC014      |

### Rubber Encased Wash Guns & Valves



| Inlet  | Blue inc Trigger Guard | Budget Blue        | R+M Dinga Style    | Stainless Steel     | RB35 + Inlet Swivel | RB65 + Inlet Swivel |                     |
|--------|------------------------|--------------------|--------------------|---------------------|---------------------|---------------------|---------------------|
| Rating | 24bar, 55lpm, 95°C     | 25bar, 50lpm, 50°C | 24bar, 100lpm 50°C | 24bar, 100lpm, 50°C | 12bar, 50lpm, 50°C  | 24bar, 60lpm, 90°C  | 24bar, 100lpm, 90°C |
| 1/2" F | GS1200PNP              | TEC005             | 50001              | GS1200ss            | 500535500           | 50056500            | 50056510            |

### Other L.P Guns & Nozzles



|         | Nito Palm Trigger   | Hand Held Rubber Protected Valve 316ss | Hand Held Valve + QRC 316ss | SS/Plastic Shower Head |
|---------|---------------------|--|-----------------------------|------------------------|
| Rated   | 6bar, 60°C          | 60bar, 95°C                            | 60bar, 95°C                 | 8bar, 60°C             |
| Inlet   | 12-19mm HT (3/4" F) | 1/2" F                                 | 1/2" F - ST3100QRC          | 1/2" F                 |
| Part No | 28002A8             | GS7500                                 | GS7510                      | 500101                 |

**Misting Nozzle Holder**

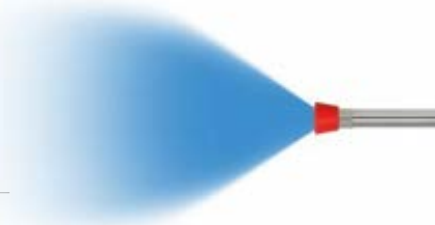

Stainless steel nozzle holder to accept the nozzles listed below. Due to the internal design of the holder, it allows the water to be sprayed in a conical mist through the nozzle. Misting nozzles are suitable for a host of applications such as disinfection, cooling, dust suppression & decontamination. Can also be used for controlling odours in the agricultural, food & construction industries. Inlet 1/4" F

|         | Misting Nozzle Holder |
|---------|-----------------------|
| Part No | 200078830             |

**Misting & Longcast Lance Nozzles**

Stainless steel nozzles to suit both the misting nozzle holder and the Longcast lances listed



| Nozzle Ø | Part No   |
|----------|-----------|
| 1.2mm    | 200078412 |
| 1.5mm    | 200078415 |
| 1.8mm    | 200078418 |
| 2.0mm    | 200078420 |
| 2.3mm    | 200078423 |
| 2.5mm    | 200078425 |
| 3.0mm    | 200078430 |
| 3.5mm    | 200078435 |

**Longcast Lances without nozzle**

The stainless steel Longcast lances can be used at both low and high pressure. The compact and sturdy design allows for ease of use close to the body. The lateral hand grip makes a stepless transition from a long range concentrated jet to a wider angled conical jet.



| Description                   | Rating                | Part No   |
|-------------------------------|-----------------------|-----------|
| Standard Lance 850mm          | 280bar, 130lpm, 100°C | 200078500 |
| Lance plus ST2300 gun, 3/8" F | 280bar, 45lpm, 100°C  | 200078510 |
| Lance plus ST2320 gun, 1/2" F | 150bar, 80lpm, 100°C  | 200078520 |



## LOW PRESSURE EQUIPMENT

### Plastic & Brass Chemical Filters



|                           | ST31      | ST31R + NRV | Fine Mesh with Metal Weight | ST32 Brass | Brass + Stainless Screen | Brass + Stainless Screen + NRV |
|---------------------------|-----------|-------------|-----------------------------|------------|--------------------------|--------------------------------|
| <b>6mm</b>                |           |             |                             | 200032800  | TPSSCF                   | TPCFNRV8                       |
| <b>6-8mm Brass Weight</b> | 200031600 | 200031610   | 73025                       |            |                          |                                |
| <b>6-8mm SS Weight</b>    | 200031615 | 200031611   |                             |            |                          |                                |

### Stainless Steel Chemical Filters



|               | ST32 Stainless | 10mm Stainless | ST32 + NRV SS | ST32 + NRV + 370mm SS Pipe<br>Stays at the bottom of the barrel |
|---------------|----------------|----------------|---------------|---|
| <b>6mm</b>    |                |                |               | 200032601   |
| <b>6-8mm</b>  | 200032600      |                |               |   |
| <b>8mm</b>    |                |                |               | 200032602   |
| <b>10mm</b>   |                | 24-11L         |               | 200032603   |
| <b>1/4" M</b> |                |                | 200032604     |   |

### Water Suction Intake Filters



|                | ST35      | ST35R + NRV | ST35 Long | Brass  | Plastic |
|----------------|-----------|-------------|-----------|--------|---------|
| <b>12mm</b>    |           |             |           |        | PWS001  |
| <b>12-19mm</b> | 200035500 | 200035510   |           | FIL010 |         |
| <b>19mm</b>    |           |             |           |        | PWS003  |
| <b>19-25mm</b> | 200035530 |             | 200035630 |        |         |

## LOW PRESSURE EQUIPMENT

### Filter Bodies



| Bowl Length | Thread | Clear Bowl  | White Bowl<br>(HV=High Volume to suit HV filters) | Clear Bowl + Drain |
|-------------|--------|-------------|---|--------------------|
| 5"          | 3/4"F  | 73450 ●     | GSFHW34-5   | 73429003 ●         |
| 5"          | 1"F    | 73460 ●     |   |                    |
| 9 3/4"      | 3/4"F  | 73470 ●     | GSFHW34-9 ●                                       | 73429004 ●         |
| 9 3/4"      | 1"F    | 73480 ●     |   | 73429005 ●         |
| 20"         | 3/4"F  | 734820034 ● |   |                    |
| 20"         | 1"F    | 734820001 ● |   |                    |

### Plastic Filter Elements



| Micron    | Cleanable |         | Cleanable Reinforced |               |            |              | Cotton (Single Use) |               |                  |
|-----------|-----------|---------|----------------------|---------------|------------|--------------|---------------------|---------------|------------------|
|           | 60        | 150     | 60                   | 80            | 120        | 250          | 5                   | 20            | 30 & 50          |
| 5"        | 73455 ●   | 73454 ● | 73429300 ●           |               |            | GSFEN5-250 ● | 73457 ●             | 73456 ●       |                  |
| 9 3/4"    | 73475 ●   | 73474 ● | 73429302 ●           |               | 73429303 ● | GSFEN9-250 ● | 73477 ●             |               | 73476 (30) ●     |
| 9 3/4" HV |           |         |                      | GSFEN9-80HV ● |            |              |                     | GSFEW9-20HV ● |                  |
| 20"       |           |         |                      | GSFEN20-80 ●  |            |              | 734720005 ●         |               | 734720050 (50) ● |

### Other Filter Elements



| Bowl Length | Melt Blown   | Stainless Steel |              | Carbon<br>For the removal of chlorine & dissolved minerals |
|-------------|--------------|-----------------|--------------|--|
|             | 1            | 50              | 80           | 250  |
| 5"          | GSFEMB5-1* ● |                 | GSFESS5-80 ● |  |
| 9 3/4"      | GSFEMB9-1* ● | 734709050 ●     |              | 734709060 ●  |
| 9 3/4" HV   |              |                 | GSFESS9-80 ● |  |

## LOW PRESSURE EQUIPMENT

### Filter Accessories



| Threaded Clear Bowl | Clear Bowl    | Metal Mounting Bracket | Single Plastic Mounting Bracket | Twin Plastic Mounting Bracket | Filter Bowl Key for Plastic Housings | Filter Key for Brass Heads | Filter Bowl 'O' Rings |
|---------------------|---------------|------------------------|---------------------------------|-------------------------------|--------------------------------------|----------------------------|-----------------------|
| 734504 5" ●         | 73420014 5" ● | 73429902 ●●            | 734507 ●●●                      | 734508 ●●●                    | 734505 ●●●                           | 73429901 ●●                | 734506 ●●●            |
| 734704 9 3/4" ●     |               |                        |                                 |                               |                                      |                            | 73420070 ●●           |

### Inline Filters (Micron)



|                | ST33 Plastic Housing | Aluminium Housing | ST33 Inline + Bowl | Plastic Inline | High Volume Inline (50µm) |
|----------------|----------------------|-------------------|--------------------|----------------|---------------------------|
| <b>Micron</b>  | 400                  | 300               | 1/2"=125, 3/4"=50  | 50             | 60                        |
| <b>1/2"</b>    | 200033540            | 730504            | 200033705          |                |                           |
| <b>3/4"</b>    | 200033550            |                   | 200033700          | 200033900      | 73440                     |
| <b>Element</b> | 120000765            | 73050403          | 020001735          | 020000670      | 734703060                 |

### Inline Filters (Mesh)



| Mesh | Micron | Material        |
|------|--------|-----------------|
| 20   | 841    | Beach Sand      |
| 50   | 297    |                 |
| 60   | 250    | Fine Sand       |
| 80   | 177    |                 |
| 100  | 147    |                 |
| 120  | 125    |                 |
| 200  | 74     | Portland Cement |
| 270  | 53     |                 |
| 325  | 44     | Silt            |
| 400  | 37     | Plant Pollen    |
|      | 12     | Talcum Powder   |
|      | 2      | Bacteria        |

|                             | 1/2"F Black Bowl inc 100 Mesh Filter Element | 3/4"F Black Bowl inc 100 Mesh Filter Element |
|-----------------------------|--|--|
| <b>Complete Filter</b>      | TPBPFH12B50                                  | TPBPFH34R100                                 |
| <b>Replacement 100 Mesh</b> | TPBPFER100                                   | TPBPFER100                                   |

## LOW PRESSURE EQUIPMENT

### Water Inlet Strainers and Check Valves



|      | Brass 'Y' Filter | Brass York Check Valve | Chrome Plated Check Valve<br>DIN 19884 + DIN EN1717 | Nylon Intake Filter with<br>Stainless Mesh |
|------|------------------|------------------------|---|--|
| 3/8" | 732038           | 733004                 |   | 73280                                      |
| 1/2" | 732012           | 733054                 |   | 73270                                      |
| 3/4" | 732034           | 733104                 | 73410   | 73260                                      |
| 1"   |                  | 73320                  |   | 73290                                      |

### WRAS Approved Float Valves



| Inlet  | Outlet   | AK + Horizontal Ball | AK + Vertical Ball | AK + PE Float | AK + PE Float | AK + Ball |
|--------|----------|----------------------|--------------------|---------------|---------------|-----------|
| 3/8"M  | 3/4"M    |                      | 701404             |               |               |           |
| 3/4"M  | 3/4"M    | 701402               |                    | 701405        | 701408        | 701403    |
| Spares | Membrane | 70142                | 70142              | 70142         | 70142         | 70142     |

### Other Float Valves



| Inlet  | Outlet   | ST8       | Peki without Float | Plastic   |
|--------|----------|-----------|--------------------|-----------|
| 3/8"M  | 8mm HT   |           | 70100              |           |
| 3/8"M  | 12mm HT  |           | 70105              |           |
| 1/2"F  | 12mm HT  | 200008520 |                    |           |
| 3/4"M  | 9mm HT   |           |                    | 701500100 |
| Spares | Float    | 030000180 | 70135              |           |
|        | Seal Kit | 200008495 | 701001             |           |

### Level Switches



|                         |           |
|-------------------------|-----------|
| LS809 Level Sensor 240v | 701880951 |
|-------------------------|-----------|



## LOW PRESSURE EQUIPMENT

### Water Tanks



60ltr stainless steel water tank with wall mounting bracket, cover and baffle plate.  
Float valve & connectors not included

| 60ltr Stainless Water Tank   |
|------------------------------|
| 105000030                    |
| 300 x 600 x 430              |
| Inlet = Ø27mm, Outlet 3/4" F |



|                  | 7ltr Plastic Tank | Tank Lid    |
|------------------|-------------------|-------------|
| <b>Part No</b>   | 020000780         | 020000800   |
| <b>W x D x L</b> | 140 x 175 x 350mm | 140 x 350mm |

### Solenoid Valves



83350



83240



| Thread             | Voltage | Burkert Type 6213 Valve | Burkert Type 6013 Valve | Sirai SS Seat Solenoid Valve | Rapa BV Fuel Solenoid |
|--------------------|---------|-------------------------|-------------------------|------------------------------|-----------------------|
|                    | Rating  | 10bar, 90°C             | 25bar, 120°C            | 20bar, 60°C                  | 24bar, 60°C           |
| 1/8" F             | 24v     |                         |                         | GS83090                      | 83020                 |
| 1/4" F             | 230v    |                         | 836137540               |                              |                       |
| 1/2" F             | 230v    | 836125660               |                         |                              |                       |
| 3/4" F             | 24v     |                         |                         |                              |                       |
| <b>Connector</b>   |         | 83350                   | 83350                   | 83350                        |                       |
| <b>1050mm Lead</b> |         |                         |                         |                              | 83240                 |

### Gauges



|            | 40mm, 1/8" M<br>Rear Entry, Plastic Housing | 40mm, 1/8" M<br>Bottom Entry, Plastic Housing | 63mm, 1/4" M<br>Bottom Entry Stainless Steel Housing |
|------------|---|---|--|
|            | Dry   | Dry   | Glycerine Filled                                     |
| 0 - 12 bar | 54750                                       |   |  |
| 0 - 16 bar |   | 54710   |  |
| 0 - 25 bar |   |   | 54890  |
| 0 - 40 bar |   |   | 54900  |

## LOW PRESSURE EQUIPMENT

### Vikan Transport System Poles



| Width      | Water Fed Lances, Inlet Nito 5 Probe | Water Fed Lances 12mm/19mm HT | Non Water Fed Lances |
|------------|--------------------------------------|-------------------------------|----------------------|
| 1m         | GS299252Q                            |                               |                      |
| 1.5m       | GS299152Q (BV)                       | 527001400                     |                      |
| 1.5 - 2.7m | GS297352Q (BV)                       | 527001402                     | GS297552             |

### Vikan Transport System Brushes



| Width | Transport Brush | Hi - Lo Wash Brush | Wheel Brush | Hand Held Water Fed |
|-------|-----------------|--------------------|-------------|---------------------|
| 230mm |                 |                    | GS545252    |                     |
| 260mm | GS475552        | GS524752           |             |                     |
| 380mm |                 |                    |             | GS525452            |
| 400mm | GS475752        |                    |             |                     |

### Other Vikan Products



| Squeegee |          | Alloy Wheel Brushes |          | Nail Brush | 665mm Stiff Workshop Broom |
|----------|----------|---------------------|----------|------------|----------------------------|
| 350mm    | GS707852 | Soft                | GS525052 | 527001409  | 527001418                  |
| 450mm    | GS707952 | Hard                | GS525352 |            |                            |

### Mr Longarm Brush & Lance System with Coarse Thread



| Length        | Blue Soft 60mm Bristle Brush | Yellow Stiff 60mm Bristle Brush | Non Water Fed Poles | Water Fed Poles + Plastic QR Probe | Angle Adaptor | Coarse Thread x 1/4" M Adaptor |
|---------------|------------------------------|---------------------------------|---------------------|------------------------------------|---------------|--------------------------------|
| 250mm         | 525000                       | 525010                          |                     |                                    | 525040        | 010003610                      |
| 900 - 1800mm  |                              |                                 | 525050              | 525200                             |               |                                |
| 1800 - 3600mm |                              |                                 | 525070              | 525300                             |               |                                |
| 2400 - 7200mm |                              |                                 | 525100              |                                    |               |                                |

## LOW PRESSURE EQUIPMENT

### Suttner Wash Brushes



| Bristle Length | ST23 Natural Bristle Brush 1/4"F.<br>Max 60°C | ST23 Natural & Synthetic Bristle Brush 1/4"F.<br>Max 60°C | Nylon Bristle Brush 1/4"F<br>Max 50°C |
|----------------|---|---|---------------------------------------|
| 60mm           | 200023550                                     |   | 52380                                 |
| 90mm           | 200023650                                     | 200023660   |                                       |

### ERIE & Vorwerk Wash Brushes



| Bristle Length | ERIE Foam Master Brush<br>with Rubber Gasket. 1/2"F, Max 60°C | Vorwerk Brush with Nylon Bristles<br>1/4"F. Max 60°C | Vorwerk brush with Natural Bristles<br>1/4"F, Max 60°C |
|----------------|---|--|--|
| 60mm           |   | 523780   | 52370  |
| 90mm           |   |  | 52375  |
| 110mm          | GSERIEB   |  |  |

### Poles for Wash Brushes



|        | ERIE Rubber Covered Wash Pole<br>3/8"F x 1/2"M Fits only onto ERIE Brush | Vorwerk Aluminium Lance. 1/4"F x M |
|--------|--|------------------------------------|
| 1000mm | GSERIEH  | 5237901                            |
| 1500mm |  | 5237902                            |

### Wash Brush Holders



|            | Wall or floor mounted stainless steel<br>brush holder, with overflow & drain |
|------------|--|
| Dimensions | 670 x 340 x 143mm  |
| Part No    | 105850   |



|            | Stainless steel wall mounted brush holder |
|------------|---|
| Dimensions | 90 x 250 x 100mm                          |
| Part No    | 10829030                                  |

## LOW PRESSURE EQUIPMENT

### Hose Hangers



| Material           | Plastic                  | Stainless Steel          | Aluminium               |                          |
|--------------------|--------------------------|--------------------------|-------------------------|--------------------------|
| Part No            | 11000                    | 11006                    | 11001                   | 110031                   |
| Capacity           | 12mm x 40m<br>19mm x 30m | 12mm x 40m<br>19mm x 30m | 6mm x 30m<br>10mm x 20m | 19mm x 30m<br>25mm x 20m |
| Dimensions (WxDxH) | 260 x 165 x 170mm        | 360 x 200 x 170mm        | 188 x 145 x 70mm        | 417 x 307 x 187mm        |

### Mains Pressure Foam Gun



|  |
|--|
| <b>Low Pressure Foam Gun with 1ltr Bottle</b><br>Multi ratio dial has 5 dosing settings and off. |
| 106996500  |
| Flow: 5.5lpm, Pressure: 2.5-6bar   |

### Descaling Pumps & Fluid



This product binds together the minerals within hard water. This reduces the build up of scale within the system, especially in boilers.

| Water Flow | Pump Flow (ml/h) | 24v       | 240v      |
|------------|------------------|-----------|-----------|
| 900+ lph   | 140              | 200015525 | 200015535 |

| 6 x 1ltr Bottles | 10ltr Drum |
|------------------|------------|
| 95010            | 95040      |



# HIGH PRESSURE EQUIPMENT

|  |    |
|--|----|
| Udor Pumps & Gearboxes                     | 30 |
| Udor Pumps & Repair Kits                   | 31 |
| Interpump Pumps & Repair Kits              | 32 |
| CAT & Speck Pumps & Repair Kits            | 33 |
| Karcher & Annovi Reverberi Repair Kits     | 34 |
| Hawk & Comet Pump Repair Kits              | 35 |
| Suttner & PA Unloader Valves               | 36 |
| Other Unloader Valves                      | 37 |
| Flow Switches & Solenoid Valves            | 38 |
| Pressure Switches, Gauges & Accumulators   | 39 |
| Chemical Injectors & Anti Vibration Mounts | 40 |

## Udor Pumps

### PNC Series 6 - 13lpm



SV version with built in unloader & injector

| Pump     | Seal Kit  | Valve Kit | Piston (x1) |
|----------|-----------|-----------|-------------|
| PNC0610s | 171606107 | 171606101 | 171120535   |
| PNC0911s | 171606107 | 171606101 | 171120535   |
| PNC1111s | 171606108 | 171606101 | 171120536   |
| PNC1312s | 171606108 | 171606101 | 171120536   |
| PNC1315s | 171606108 | 171606101 | 171120536   |

Misting

| Model     | Flow (lpm) | Pressure (bar) | RPM  | Power KW/HP |     | Shaft Size | Inlet - Outlet |
|-----------|------------|----------------|------|-------------|-----|------------|----------------|
| PNC0610s  | 6          | 100            | 1450 | 1.1         | 1.5 | 24mm       | 3/8" F         |
| PNC0911s  | 9          | 110            | 1450 | 1.9         | 2.5 | 24mm       | 3/8" F         |
| PNC0911sv | 9          | 110            | 1450 | 1.9         | 2.5 | 24mm       | 3/8" F         |
| PNC1111s  | 11         | 110            | 1450 | 2.3         | 3.1 | 24mm       | 3/8" F         |
| PNC1312s  | 13         | 120            | 1450 | 2.9         | 4.0 | 24mm       | 3/8" F         |
| PNC1315sv | 13         | 150            | 1450 | 3.7         | 5.0 | 24mm       | 3/8" F         |

### BC Series 13 - 21lpm



| Pump     | Seal Kit  | Valve Kit | Piston    |
|----------|-----------|-----------|-----------|
| BC1320s  | 171606109 | 171606102 | 171120572 |
| BC1515s  | 171606128 | 171606102 | 171120571 |
| BC1520s  | 171606128 | 171606102 | 171120571 |
| BKC1530s | 171606128 | 171606130 | 171120571 |
| BC1820s  | 171606128 | 171606102 | 171120571 |
| BC2120s  | 171606128 | 171606102 | 171120571 |

| Model    | Flow (lpm) | Pressure (bar) | RPM  | Power KW/HP |      | Shaft Size | Inlet - Outlet  |
|----------|------------|----------------|------|-------------|------|------------|-----------------|
| BC1320s  | 13         | 200            | 1450 | 5.0         | 6.7  | 24mm       | 1/2" F - 3/8" F |
| BC1515s  | 15         | 150            | 1450 | 4.3         | 5.8  | 24mm       | 1/2" F - 3/8" F |
| BC1520s  | 15         | 200            | 1450 | 5.7         | 7.7  | 24mm       | 1/2" F - 3/8" F |
| BKC1530s | 15         | 300            | 1450 | 8.6         | 11.5 | 24mm       | 1/2" F - 3/8" F |
| BC1820s  | 18         | 200            | 1450 | 7.1         | 9.5  | 24mm       | 1/2" F - 3/8" F |
| BC2120s  | 21         | 200            | 1450 | 8.1         | 10.8 | 24mm       | 1/2" F - 3/8" F |

### CC Series 21 - 42lpm



| Pump      | Seal Kit  | Valve Kit | Piston    |
|-----------|-----------|-----------|-----------|
| CC21 & 26 | 171606110 | 171606103 | 171112532 |
| CB3020    | 171606112 | 171606103 | 171120534 |
| CC3020    | 171606111 | 171606103 | 171120533 |
| CC3817    | 171606112 | 171606103 | 171120534 |

| Model   | Flow (lpm) | Pressure (bar) | RPM  | Power KW/HP |      | Shaft Size | Inlet - Outlet  |
|---------|------------|----------------|------|-------------|------|------------|-----------------|
| CC2120s | 21         | 200            | 1450 | 8.1         | 10.8 | 24mm       | 3/4" F - 3/8" F |
| CC2620s | 26         | 200            | 1450 | 9.9         | 13.3 | 24mm       | 3/4" F - 3/8" F |
| CB3020s | 30         | 200            | 1000 | 11.5        | 15.4 | 24mm       | 3/4" F - 1/2" F |
| CC3020s | 30         | 200            | 1450 | 11.5        | 15.4 | 24mm       | 3/4" F - 1/2" F |
| CC3817s | 38         | 170            | 1450 | 12.4        | 16.6 | 24mm       | 3/4" F - 1/2" F |

## Udor Pumps & Repair Kits

### CKC Series - 34 to 50lpm



| Pump     | Seal Kit  | Valve Kit | Piston    |
|----------|-----------|-----------|-----------|
| CKC3425s | 171606111 | 171606103 | 171120533 |
| CKC5020s | 171606112 | 171606103 | 171120534 |

| Model    | Flow (lpm) | Pressure (bar) | RPM  | Power KW/HP |      | Shaft Size | Inlet - Outlet  |
|----------|------------|----------------|------|-------------|------|------------|-----------------|
|          |            |                |      |             |      |            |                 |
| CKC3425s | 34         | 250            | 1450 | 16.3        | 21.8 | 24mm       | 3/4" F - 3/8" F |
| CKC5020s | 50         | 200            | 1450 | 19.1        | 25.6 | 24mm       | 1" F - 1/2" F   |

### WTC Series - 11 to 34lpm, upto 85°C

| Pump  | Seal Kit  | Valve Kit | Piston    |
|-------|-----------|-----------|-----------|
| PKWTC | 1716061N5 | 171606102 | 171120554 |
| BWTC  | 171670002 | 171606143 | 171120571 |
| CWTC  | 1716061N9 | 171606103 | 171120533 |



| Model      | Flow (lpm) | Pressure (bar) | RPM  | Power KW/HP |      | Shaft Size | Inlet - Outlet  |
|------------|------------|----------------|------|-------------|------|------------|-----------------|
|            |            |                |      |             |      |            |                 |
| PKWTC1115s | 11         | 150            | 1450 | 3.1         | 4.2  | 24mm       | 1/2" F - 3/8" F |
| PKWTC1315s | 13         | 150            | 1450 | 3.7         | 5.0  | 24mm       | 1/2" F - 3/8" F |
| BWTC1820s  | 18.5       | 200            | 1450 | 7.1         | 9.5  | 24mm       | 1/2" F - 3/8" F |
| BWTC2120s  | 21         | 200            | 1450 | 8.1         | 10.8 | 24mm       | 1/2" F - 3/8" F |
| CWTC2720s  | 27         | 200            | 1450 | 10.3        | 13.8 | 24mm       | 3/4" F - 3/8" F |
| CWTC3420s  | 34         | 200            | 1450 | 12.8        | 17.4 | 24mm       | 3/4" F - 3/8" F |

## Reduction Gearboxes



| Power source | Udor RC122 1" up to 22HP | Udor MTP125 - up to 27 HP | Type B 18 - 8-13KW | RS500 - upto 18.5KW |
|--------------|--------------------------|---------------------------|--------------------|---------------------|
| Ratio        | 2.176:1                  | 1:2.5                     | 1:2176             | 1:2.2               |
| Part No      | RC122                    | MTP125                    | 176000000          | GSR500              |

# HIGH PRESSURE EQUIPMENT

## Interpump Pumps & Repair Kits



| Model | Part No   | Pressure | Flow | RPM  | KW  | Valve Kit | Seal Kit  | Ceramic Piston x 1 | Ceramic Size |
|-------|-----------|----------|------|------|-----|-----------|-----------|--------------------|--------------|
| W140  | -00140001 | 140      | 12   | 1450 | 3   | -34012301 | -34012701 | -44040109          | 18 x 37.5mm  |
| W140B | -00140004 | 140      | 12   | 1450 | 3   | -34012301 | -34012701 | -44040109          | 18 x 37.5mm  |
| W154  | -00154001 | 150      | 14   | 1450 | 4   | -34012301 | -34012701 | -44040109          | 18 x 37.5mm  |
| WS151 | -00151001 | 150      | 15   | 1450 | 4   | -34000101 | -34006901 | -47040409          | 20 x 50mm    |
| WS201 | -00201001 | 200      | 15   | 1450 | 5.5 | -34000101 | -34006901 | -47040409          | 20 x 50mm    |
| WS202 | -00202001 | 200      | 21   | 1450 | 7.5 | -34000101 | -34006901 | -47040409          | 20 x 50mm    |

## Interpump Service Kits

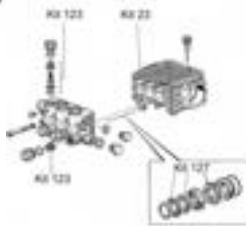

**Service Kits include:  
Valve Kit, Seal Kit & Oil Seal Kit**

|           | Part No | Fits  |
|-----------|---------|---|
| Series 44 | IPSER44 | W130, W140, W150, W154, WW209                   |
| Series 47 | IPSER47 | WS102, WS133, WS151, WS152, WS162, WS201, WS202 |
| Series 50 | IPSER50 | W98, W99, WW161,                                |

## Stocked Interpump Repair Kits

| Kit No | Description           | Kit No | Description           | Kit No | Description                 | Kit No | Description        |
|--------|-----------------------|--------|-----------------------|--------|-----------------------------|--------|--------------------|
| 1      | Valve Kit             | 69     | Seal Kit              | 131    | Seal Packing Kit x 1 Piston | 201    | Valve Kit          |
| 2      | Oil Seal kit          | 88     | Seal Kit              | 137    | Type H Unloader Rep Kit     | 202    | High Temp Seal Kit |
| 4      | Valve Plugs (x6)      | 96     | Seal Packing Kit (x1) | 148    | Seal Kit                    | 220    | High Temp SK & VK  |
| 7      | Plastic Seal Supports | 97     | Seal Kit              | 160    | Seal Kit                    | 269    | Valve Kit          |
| 19     | Seal Kit              | 102    | Brass Check Valve     | 161    | Seal Kit                    | 285    | Seal Kit           |
| 23     | Oil Seal Kit          | 123    | Valve Kit             | 169    | Valve Kit                   | 286    | Seal Kit           |
| 28     | Seal Packing Kit (x1) | 127    | Seal Kit              | 181    | Seal Kit                    |        |                    |

## Interpump Accessories



| Ceramic Piston (x1) |           |
|---------------------|-----------|
| 15 x 25             | -51040009 |
| 15 x 38             | -52040009 |
| 18 x 37.5           | -44040109 |
| 20 x 40             | -50040409 |
| 20 x 50             | -47040409 |
| 22 x 50             | -47040509 |

| Drive Couplings |               |           |
|-----------------|---------------|-----------|
| ZG091           | 28 x 24 (93)  | -10001911 |
| ZG044           | 28 x 24 (102) | -10000441 |
| ZG151           | 28 x 24 (105) | -10015111 |

| Flange |     |           |           |
|--------|-----|-----------|-----------|
| Model  | ↔ X | Y         | Part No   |
| ZF091  | 101 | 110 x 130 | -10000910 |
| ZF151  | 110 | 110 x 130 | -10001510 |

| Dipsticks/Breathers |           |
|---------------------|-----------|
| 80mm                | -98210300 |
| 90mm                | -98210600 |
| 120mm               | -98209700 |



Rubber Pad for Coupling  
-10009047



1Ltr Interpump Oil  
-99900000



3/4" M Sight Glass  
GS035



## CAT Pumps Repair Kits



| Model                  | Seal Kit | Valve Kit        | Piston  |
|------------------------|----------|------------------|---------|
| <b>3CP1120, 30, 40</b> | 1333983  | 1333062 (x2 req) | 1346976 |
| <b>5CP21</b>           | 1333628  | 1330821 (x2 req) | 1346841 |
| <b>5CP31</b>           | 1333629  | 1333060 (x2 req) | 1346884 |
| <b>5CP51</b>           | 1333630  | 1333060 (x2 req) | 1346893 |
| <b>45 &amp; 45L</b>    | 1330629  | 1330683 (x2 req) | 1345783 |

| Model                | Seal Kit | Valve Kit        | Piston  |
|----------------------|----------|------------------|---------|
| <b>230, 240, 270</b> | 1330914  | 1330915          | 1343901 |
| <b>310, 340, 350</b> | 1330623  | 1330821 (x2 req) | 1343367 |
| <b>550</b>           | 1330610  | 1330820          |         |
| <b>650</b>           | 1330798  | 1330820          | 1343300 |
| <b>1050</b>          | 1330913  | 1334920          | 1343552 |



## Other Stocked Genuine CAT Parts

| Part No        | Description             | Part No        | Description         | Part No        | Description       |
|----------------|-------------------------|----------------|---------------------|----------------|-------------------|
| <b>1317547</b> | 3CP Valve Plug 'O' Ring | <b>1343228</b> | Piston Rod Oil Seal | <b>1345789</b> | Case Seal         |
| <b>1331040</b> | 3535 Seal Kit           | <b>1343320</b> | Female Adaptor      | <b>1346730</b> | Piston Seal       |
| <b>1334260</b> | 66DX Valve Kit (x2 req) | <b>1343900</b> | Barrier Slinger     | <b>1346798</b> | 5CP Filler Cap    |
| <b>1334262</b> | 66DX Seal Kit           | <b>1345784</b> | 45 Seal Retainer    | <b>1346839</b> | 3CP Oil Seal (x1) |



## CAT Pump Accessories



| Model   | Bell Housing | Drive Coupling | 1ltr CAT Pump & Gearbox Oil |
|---------|--------------|----------------|-----------------------------|
| 3CP     |              | 1330736        | 13701101                    |
| 5CP     | 13701730     | 1330721        |                             |
| 240-270 | 1330738      | 1330736        |                             |
| 310-340 | 1330715      | 1330721        |                             |

## Speck Pump Repair Kits



| Model                  | Seal Kit | Valve Kit |
|------------------------|----------|-----------|
| <b>NP10/10, 13, 15</b> | 18140444 | 18140364  |
| <b>NP16/14, 15</b>     | 18140454 | 18140364  |
| <b>NP25/21, 25</b>     | 18140734 | 18140733  |
| <b>NP25/30, 38</b>     | 18140399 | 18140397  |
| <b>NP25/41, 50</b>     | 18140400 | 18140397  |
| <b>P11/10, 13, 15</b>  | 18140494 | 18140496  |
| <b>P21/15</b>          | 18140498 | 18140496  |
| <b>P21/18, 23</b>      | 18140500 | 18140497  |

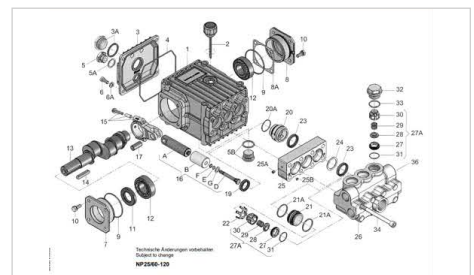

Full technical specifications and exploded diagrams can be found on our website:

[gspen.co.uk](http://gspen.co.uk)

## HIGH PRESSURE EQUIPMENT

### Karcher Equivalent Repair Kits

| Model       | Piston Ø | Seal kit | H.P Seal (x1) | L.P Seal (x1) | Oil Seal (x1) | Valve Kit | Pistons (x3) |
|-------------|----------|----------|---------------|---------------|---------------|-----------|--------------|
| HDS501      | 12       | 1563420  |               |               |               |           |              |
| HD585/645   | 14       | 1563250  |               |               |               |           |              |
| HD575/790   | 16       | 1563240  |               |               |               |           |              |
| HD755/1020  | 18       | 1563170  |               |               |               |           |              |
| HDS 551     | 14       | 1563250  |               | KARSL14       | KARSL105      | 1514100   |              |
| HDS 601 ECO | 14       | 1563250  |               | KARSL14       | KARSL105      | 1514100   |              |
| HDS 655     | 18       | 1563170  | KARSH18       | KARSL18       |               | 1514100   |              |
| HDS 790     | 18       | 1563170  | KARSH18       | KARSL18       |               | 1514100   |              |
| HDS 890C    | 18       | 1563170  | KARSH18       | KARSL18       |               | 1514100   |              |
| HDS 895     | 18       | 1563170  | KARSH18       | KARSL18       |               | 1514100   |              |
| HDS 610     | 20       | 1563470  | KARSH20       | KARSL20       |               | 1514100   |              |
| HDS 745     | 20       | 1563470  | KARSH20       | KARSL20       |               |           |              |
| HDS 750     | 20 x 35  | 1563470  | KARSH20       | KARSL20       |               |           | KARP2035     |
| HDS 755     | 20       | 1563460  |               |               |               |           |              |
| HDS 995     | 20       | 1563460  |               |               |               |           |              |

### Annovi Reverberi Motor Pumps & Repair Kits



| Model   | HRC 11.12   | HXM 15.15  |
|---------|---|--|
|         | 2.2KW Motor, Unloader, Total Stop, Cable, On/Off Switch | 4KW Motor, Unloader, Gauge, Total Stop & 5m Cable, On/Off Switch |
| Rating  | 11lpm, 120bar   | 15lpm, 150bar  |
| Part No | 17028023  | 170208711  |

| Model     | Piston Ø x L | Seal Kits |            | Valve Kits |            | Oil Seal Kit                 | Ceramic Pistons (x3)              |
|-----------|--------------|-----------|------------|------------|------------|------------------------------|-----------------------------------|
|           |              | Genuine   | Equivalent | Genuine    | Equivalent | Equivalent                   | 170 = Genuine<br>140 = Equivalent |
| RC        | 18 x 30      | 17042469  |            | 1702186    |            | 17042468* <sub>Genuine</sub> | 17042467                          |
| RK        | 18 x 40      | 1701857   | 140001857  | 1702864    | 140002864  | ARSGK003                     | 140002757                         |
| RKV       | 18 x 40      | 1701857   | 140001857  |            | 140001828  |                              | 140002757                         |
| RW        | 28 x 45      | 17042171  |            | 17042169   |            | 1702873* <sub>Genuine</sub>  | 1701849                           |
| SXM       | 15 x 30      | 1702747   | 140002747  | 1701864    | 140001864  |                              |                                   |
| XM        | 18 x 35      | 1702747   | 140002747  | 1701864    | 140001864  |                              | 1702746                           |
| XMA       | 15 x 35      | 1702741   | 140002741  | 1701864    | 140001864  |                              |                                   |
| XMV       | 15 x 35      | 1702741   | 140002741  | 1701864    | 140001864  |                              |                                   |
| XT        | 15 x 30      |           | 140001866  | 1701864    | 140001864  | AROSGK002                    |                                   |
| XT        | 18 x 30      |           | 140001874  | 1701864    | 140001864  | AROSGK002                    |                                   |
| XTS       | 15 x 30      |           | 140001866  | 1701864    | 140001864  | AROSGK002                    |                                   |
| XTV       | 18 x 30      |           | 140001874  | 1701864    | 140001864  | AROSGK002                    |                                   |
| XW        | 20 x 45      | 1702782   | 140002782  | 1702780    |            | 1702781* <sub>Genuine</sub>  |                                   |
| NEPTUNE 5 | 18 x 40      | 1701857   | 140001857  | 1702864    | 140002864  |                              | 140002757                         |

## Hawk Pump and Repair Kits



| Pump     | Flow (lpm) | Pressure (bar) | RPM  | Part No   |
|----------|------------|----------------|------|-----------|
| NMT1520R | 15         | 200            | 1450 | 174015200 |

| Model            | Piston Ø (mm) | Seal Kits |            | Valve Kits (x6) |            | Ceramic Pistons |                 |
|------------------|---------------|-----------|------------|-----------------|------------|-----------------|-----------------|
|                  |               | Genuine   | Equivalent | Genuine         | Equivalent | Genuine (x1)    | Equivalent (x3) |
| NMT Range        | 20            | HA260077  |            | HA19055430      |            | HA260107        |                 |
| NMT CW Range     | 20            | HA260123  |            | HA19055430      |            | HA260107        |                 |
| NHD 150 Range    | 16            | HA260189  |            |                 |            |                 |                 |
| HD 10/1115 Range | 18            | HA260044  |            | HA260028        |            |                 |                 |
| XLT3517/4017     | 25            | HA260113  |            | HA260010        |            |                 |                 |
| XLT3020/25       | 22            | HA260125  |            |                 |            | HA260129        |                 |
| HC240i           | 18            | 160164201 | HAWSK001   | HA260002        | HAWV001    |                 |                 |
| HC310, 340 & 350 | 18 x 46       | 160164201 | HAWSK001   |                 | HAWVK003   |                 |                 |
| H450             | 20 x 53       | HA260000  |            |                 | HAWV001    | HA260004        |                 |
| HC450            | 20 x 46       | HA260801  | HAWSK003   |                 | HAWV001    | HA260802        | HAWP020         |
| HC500, 550       | 20 x 46       | HA260801  | HAWSK003   |                 | HAWV001    | HA260802        | HAWP020         |
| HC506 SIR        | 20 x 46       | HA260801  | HAWSK003   | HA19055430      |            | HA260802        | HAWP020         |
| HC600            | 20 x 53       | HA260000  |            |                 | HAWV001    |                 |                 |
| H600/700         | 25 x 53       | HA260200  |            |                 | HAWV001    |                 |                 |
| HC800            | 25 x 53       | HA260200  |            |                 | HAWV001    | HA260203        |                 |
| HC930/940        | 22 x 53       |           |            | HA260010 (x1)   |            |                 |                 |
| HC950            | 25 x 53       | HA262907  |            | HA260010 (x1)   |            |                 |                 |

## Comet Pump & Repair Kits



| Pump     | Flow (lpm) | Pressure (bar) | RPM  | Part No |
|----------|------------|----------------|------|---------|
| AXD3020G | 10.2       | 137            | 3400 | AXD3020 |

| Model        | Piston Ø (mm) | Seal Kits    |            | Valve Kits  |            |
|--------------|---------------|--------------|------------|-------------|------------|
|              |               | Genuine      | Equivalent | Genuine     | Equivalent |
| AXD3020      | 14            | GSC5019-0077 |            | GSC50250014 |            |
| FW4030s      | 18            | 172900023    | COMS1818   | 172900001   | COMV26     |
| FW5030-5530s | 20            | 172900024    | COMS1820   | 172900001   | COMV26     |
| FW2 4030     | 18            | GSC50190218  |            | 172900001   | COMV26     |
| FW2 4040     | 18            | GSC50190631  |            | 172900001   | COMV26     |
| LW           | 18            | GSC50190037  |            | 172900001   | COMV26     |
| LWD          | 15            | GSC5019.0035 |            | 172900001   | COMV26     |
| RW           | 20            | GSC50190672  |            | 172900001   | COMV26     |
| ZW3020       | 18            | GSC50190652  |            | 172900001   | COMV26     |
| ZWD          | 15            | GSC50190064  |            | 172900001   | COMV26     |

## Suttner Unloader Valves



| Model            | ST250               | ST261               | ST261 + Pressure Switch | ST265               | ST265 + Pressure Switch | ST280               |
|------------------|---------------------|---------------------|-------------------------|---------------------|-------------------------|---------------------|
| Rating           | 250bar, 35lpm, 60°C | 250bar, 30lpm, 80°C | 250bar, 30lpm, 80°C     | 350bar, 50lpm, 80°C | 350bar, 50lpm, 80°C     | 250bar, 30lpm, 80°C |
| Standard Version | 200250500           | 200261500           | 200261551               | 200265500           | 200265550               | 200280500           |
| P/ Mount Version |                     | 200261559           |                         |                     |                         |                     |
| Inlet            | 3/8" F              | 3/8" F              | 3/8" F                  | 3/8" F              | 3/8" F                  | 3/8" F              |
| Outlet           | 3/8" F              | 3/8" F              | 3/8" F                  | 3/8" F              | 3/8" F                  | 3/8" F              |
| Bypass           | 1/4" F              | 1/4" F              | 1/4" F                  | 3/8" F              | 3/8" F                  | 1/4" F              |
| Gauge Port       | 1/4" F              | 1/4" F              | 1/4" F                  | 1/4" F              | 1/4" F                  | 1/4" F              |

## VB Unloader Valves



| Model      | VB7           | VB9           | VB9 + Pressure Switch | VB75<br>To fit Interpump | VB85          | VB350         |
|------------|---------------|---------------|-----------------------|--------------------------|---------------|---------------|
| Rating     | 220bar, 30lpm | 220bar, 30lpm | 220bar, 30lpm         | 220bar, 30lpm            | 280bar, 80lpm | 350bar, 40lpm |
| Part No    | GSVB7         | GSVB9         | GSVB9PS               | GSVB75                   | GSVB85        | GSVB350       |
| Inlet      | 3/8" F        | 3/8" F        | 3/8" F                | 1/2" M                   | 1/2" F        | 3/8" M        |
| Outlet     | 3/8" F        | 3/8" F        | 3/8" F                | 3/8" F                   | 1/2" F        | 3/8" F        |
| Bypass     | 3/8" F        | 3/8" F        | 3/8" F                |                          | 1/2" F        | 1/2" F        |
| Gauge Port |               | 1/4" F        | 1/4" F                |                          |               |               |

## Speck Unloader Valves



| Model      | UL180H             | UL221               | UL262                |
|------------|--------------------|---------------------|----------------------|
| Rating     | 210bar, 30lpm 80°C | 200bar, 50lpm, 80°C | 280bar, 100lpm, 80°C |
| Part No    | 18000989           | 18000817            | 18004815             |
| Inlet      | 3/8" F             | 1/2" F              | 3/4" F               |
| Outlet     | 3/8" F             | 1/2" F              | 3/4" F               |
| Bypass     | 1/4" F             | 1/2" F              | 3/4" F               |
| Repair Kit |                    |                     | 18140554             |

# HIGH PRESSURE EQUIPMENT

## Other Unloader Valves



| Model               | VRT3                 | VRT3 + Pressure Switch | Interpump K3                                | Interpump K5                                 | Interpump W2-1      | Gymatic 3B<br>A&R XM & RK Pumps |
|---------------------|----------------------|------------------------|---|--|---------------------|---------------------------------|
| Rating              | 220 bar, 30lpm, 90°C |                        | 100bar, 80°C                                | 200bar, 80°C                                 | 200bar, 15lpm, 60°C | 250bar, 18lpm, 60°C             |
| Standard Version    | GSVRT3               | GSVRT3PS               | K3.0 8-11 -10000030<br>K3.1 11-16 -10000031 | K5.1 11-16 -10000051<br>K5.2 16-25 -10000052 | -01000230           | GS20400                         |
| Panel Mount Version | GSVRT3PM             |                        |   |  |                     |                                 |
| Inlet               | 3/8" F               | 3/8" F                 | 3/8" F                                      | 3/8" F                                       | 1/2" F              | 1/2" M                          |
| Outlet              | 3/8" F               | 3/8" F                 | 1/2" M                                      | 1/2" M                                       | 3/8" M              | 3/8" M                          |
| Bypass              | 3/8" F               | 3/8" F                 |   |  |                     |                                 |
| Gauge Port          | 1/4" F               | 1/4" F                 |   |  |                     |                                 |

## Safety Valves



| Model   | VS240<br>Max 240bar | ST230<br>Max 250bar | S250<br>Max 250bar | ST230<br>Max 350bar | VS350<br>Max 350bar | VS500<br>Max 500bar | ST230<br>Max 700bar | ST220<br>Max 700bar |
|---------|---------------------|---------------------|--------------------|---------------------|---------------------|---------------------|---------------------|---------------------|
| Rating  | 24lpm, 60°C         | 30lpm, 95°C         | 35lpm, 95°C        | 30lpm, 95°C         | 25lpm, 90°C         | 80lpm, 90°C         | 40lpm, 60°C         | 50lpm, 85°C         |
| Part No | 5305250             | 200230501           | 53010              | 200230601           | GSVS350             | GSVS500             | 200230700           | 200220500           |
| Inlet   | 3/8" F              | 1/4" F              | 3/8" F             | 1/4" F              | 3/8" F              | 1/2" F              | 1/4" F              | 1/2" M              |
| Outlet  | 3/8" F              | 1/4" F              | 1/4" F             | 1/4" F              | 3/8" F              | 3/8" F              | 1/4" F              | -                   |

## Suttner Check & Easy Start Valves



| Model  | ST264 Brass<br>0.05 - 0.1bar | ST264 Stainless Steel<br>0.05 - 0.1bar | ST264 Stainless Steel<br>0.05 - 0.1bar | ST232 Easy Start Valve<br>1/4" M x 3/8" M | Thermal Relief Valve |
|--------|------------------------------|--|--|---|----------------------|
| Rating | 150bar                       | 400bar                                 | 400bar                                 | 280bar, 30lpm                             | 10bar, 63°C          |
| 1/4"   | 200264510                    | 200264500                              | 200264500                              | 200232510                                 |                      |
| 3/8"   | 200264530                    | 200264520                              |  |   | 91065                |
| 1/2"   |                              | 200264540                              |  |   | 91055                |

## Suttner ST5 Flow Switches



| Version                         | ST5<br>Vertical Mount | ST5 Low Flow<br>Vertical Mount | ST5<br>Vert/Horizontal Mount | ST5 High Flow<br>Vertical Mount | ST505<br>Vertical Mount |
|---------------------------------|-----------------------|--------------------------------|------------------------------|---------------------------------|-------------------------|
| <b>Rating</b>                   | 350bar, 30lpm, 80°C   | 350bar, 30lpm, 80°C            | 350bar, 30lpm, 80°C          | 210bar, 60lpm, 80°C             | 600bar, 30lpm, 80°C     |
| <b>Part No</b>                  | 200005501             | 200005558                      | 200005601                    | 200005701                       | 200505709               |
| <b>Close/Open</b>               | 3.4/2.9               | 0.3/0.17                       | 5.2/4.2                      | 5.2/4.2                         |                         |
| <b>Thread</b>                   | 3/8" F                | 3/8" F                         | 3/8" F                       | 1/2" F                          | 3/8" F                  |
| <b>Spares</b>                   |                       |                                |                              |                                 |                         |
| <b>Spare Magnet + Hole</b>      | 200005518             |                                | 200005518                    | 200005528                       | 200005301               |
| <b>Spare Magnet w/o Hole</b>    |                       | 200005526                      |                              |                                 |                         |
| <b>Spare Reed Switch (1200)</b> | 200005435             | 200005435                      | 200005435                    | 200005435                       | 200005435               |
| <b>Spare Reed Switch (3600)</b> | 200005438             | 200005438                      | 200005438                    | 200005438                       | 200005438               |

## ST6 & ST7 Flow Switches



The ST7 uses microswitches instead of reed switches, will allow for a greater number of switches, whilst allowing for a higher electrical output. The physical barrier between the water and micro switch allow this switch to achieve an IP65 rating. Due to the design, low switching points can be realised, regardless of the maximum water flows. The pressure drop at 30lpm is only 1.5 bar.

3/8" F, Rated to 350bar, 45lpm & 80°C.

|                          | ST6<br>Vertical/Horizontal Mount |
|--------------------------|----------------------------------|
| <b>Rating</b>            | 310bar, 30lpm, 80°C              |
| <b>Part No</b>           | 200006500                        |
| <b>Thread</b>            | 3/8" M                           |
| <b>Spare Magnet</b>      | 200006490                        |
| <b>Spare Reed Switch</b> | 200006436                        |

| Switch Point                    | Part No   | Spare Floater/Magnet |
|---------------------------------|-----------|----------------------|
| <b>1.5lpm</b>                   | 200007510 | 200007499            |
| <b>4lpm</b>                     | 200007500 | 200007497            |
| <b>Spare Switch &amp; Cable</b> | 200007498 |                      |

## High Pressure Solenoid Valves



|                    | RAPA SV04 Solenoid Valve | AK Solenoid Valve    | 3 Pin Connector |
|--------------------|--------------------------|----------------------|-----------------|
| <b>Rating</b>      | 1/4" F, 0-130bar, 90°C   | 1/4" F, 0-180bar, 90 | 83350           |
| <b>24v</b>         |                          | 83310                |                 |
| <b>24v - 50Hz</b>  | 83200                    |                      |                 |
| <b>230v - 50Hz</b> | 83210                    |                      |                 |

## Pressure Switches



|                       | Suttner ST7.1<br>IP65 Rated | PR5                  | PR16                 |                  | Diaphragm Switch SW27     |                     | Condor/Fanal Switch |
|-----------------------|-----------------------------|----------------------|----------------------|------------------|---------------------------|---------------------|---------------------|
| <b>Rating</b>         | 300bar, 90°C, 1/4" M        | 250bar, 90°C, 1/4" M | 250bar, 60°C, 1/4" M | <b>Rating</b>    | 4A, 24-250v, 300bar, 90°C | <b>Rating</b>       | 250bar, 3/8" F      |
| <b>Cable Length</b>   | 950mm                       | 1000mm               | 1200mm               | <b>Inlet</b>     | 1/4" M                    | <b>.22-4 bar</b>    | 91150               |
| <b>15 bar - Blue</b>  |                             | 912515               | GS29004040           | <b>Part No</b>   | 913186203                 | <b>2 - 32 bar</b>   | 91140               |
| <b>25 bar - Red</b>   | 200007801                   | 912525               | GS29004030           | <b>Connector</b> | 913118002                 | <b>30 - 250 bar</b> | 91120               |
| <b>40 bar - Black</b> | 200007800                   | 912540               | GS29004020           |                  |                           |                     |                     |

## Pressure Gauges



| Pressure        | 40mm Back Entry<br>Plastic Case | 50mm Bottom Entry<br>Stainless Steel | 50mm Back Entry<br>Stainless Steel | 63mm Bottom Entry<br>Stainless Steel | 63mm Back Entry<br>Stainless Steel | 63mm Panel<br>Mounted Back Entry |
|-----------------|---------------------------------|--------------------------------------|------------------------------------|--------------------------------------|------------------------------------|----------------------------------|
|                 | 1/8" M                          | 1/4" M                               | 1/4" M                             | 1/4" M                               | 1/4" M                             | 1/4" M                           |
| <b>100 bar</b>  |                                 |                                      |                                    | 54910                                | 54810                              |                                  |
| <b>160 bar</b>  |                                 |                                      |                                    | 54920                                | 54820                              |                                  |
| <b>250 bar</b>  | 54837                           | 54935                                | 54835                              | 54930                                | 54830                              | 54990                            |
| <b>400 bar</b>  |                                 | 54945                                | 54843                              | 54940                                | 54840                              |                                  |
| <b>600 bar</b>  |                                 |                                      |                                    | 54950                                |                                    |                                  |
| <b>1000 bar</b> |                                 |                                      |                                    |                                      | 548631000                          |                                  |

## Gauge Accessories & Accumulators



| Length        | M12F x M10M     | 1/4" F x 1/4" F | Gauge Ø | Fixing Bracket | 0.07ltr Accumulator<br>M14M, 15-200bar | 0.21ltr Accumulator<br>25-220bar | 0.35ltr Accumulator<br>3/8" F, 40-120bar |
|---------------|-----------------|-----------------|---------|----------------|--|----------------------------------|--|
| <b>Rating</b> | DN2, Max 250bar | DN2, Max 250bar | 50mm    | 54855          | 1893070                                | M16M<br>1893210                  | 1892110                                  |
| <b>300mm</b>  |                 | 4952520300      | 63mm    | 54850          |  | 3/8" M<br>1893212                |  |
| <b>405mm</b>  | 4952610405      |                 |         |                |  |                                  |  |
| <b>500mm</b>  |                 | 4952520500      |         |                |  |                                  |  |
| <b>700mm</b>  |                 | 4952520700      |         |                |  |                                  |  |

## Brass Chemical Injectors



|                     |                   | ST60 Chemical Inj     | ST60.1 Foam Inj<br>SS Internals | ST60.1 Injector + KW<br>QRC, ST61, 1m Chem<br>Pipe & ST31R Filter | ST60.1 Injector + M22<br>M&F, ST61, 1m Chem<br>Pipe & ST31R Filter | RM300 + Metering Valve |
|---------------------|-------------------|-----------------------|---------------------------------|---|--|------------------------|
| <b>Inj Size</b>     | <b>Flow Range</b> | 250bar, 60°C          | 250bar, 60°C                    | 250bar, 60°C  | 250bar, 60°C   | 220bar, 60°C           |
| <b>1.6mm</b>        |                   |                       | 200060700                       | 200060750   | 200060760  |                        |
| <b>1.8mm</b>        | <b>8-11</b>       | 200060600             | 200060710                       |   |  | 5443181                |
| <b>2.1mm</b>        | <b>11-16</b>      | 200060610             |                                 |   |  | 5443211                |
| <b>2.4mm</b>        | <b>16-21</b>      | 200060620             |                                 |   |  | 5443231                |
| <b>Inlet/Outlet</b> |                   | 3/8" M In, 3/8" F Out | 3/8" M In, 3/8" F Out           | Coupling In, Probe Out  | M22F In, M22M Out  | 3/8" M In, 3/8" F Out  |
| <b>Repair Kit</b>   |                   | 200060725             | 200060725                       | 200060725   | 200060725  |                        |

## Chemical Injector Accessories



|            | 30m Roll of 6mm Clear PVC | ST31 Chemical Filter | ST31 Chemical Filter + NRV | Suction Set inc<br>320mm Tube, 1500mm Pipe<br>& ST31 Filter | ST61 Chemical Valve |
|------------|---------------------------|----------------------|----------------------------|---|---------------------|
| <b>6mm</b> | 30620                     | 200031600            | 200031610                  | 200031500   | 200061500           |
| <b>8mm</b> | 30630                     | 200031600            | 200031610                  |   |                     |

## High Pressure Pump Accessories



| Burst Discs    |        |           |
|----------------|--------|-----------|
| Pressure       | Colour | Part No   |
| <b>1800psi</b> | Yellow | GSBDY1800 |
| <b>2000psi</b> | Blue   | GSBDB2000 |
| <b>2500psi</b> | Red    | GSBDR2500 |
| <b>3000psi</b> | Purple | GSBDP3000 |
| <b>3500psi</b> | Green  | GSBDG3500 |
| <b>4000psi</b> | White  | GSBDW4000 |
| <b>5000psi</b> | Black  | GSBDK5000 |
| <b>6000psi</b> | Orange | GSBDO6000 |

| Burst Disc Holder<br>1/2" F |
|-----------------------------|
| GSBDN                       |

| Anti Vibration Mounts |         |            |
|-----------------------|---------|------------|
| Size Ø x H (mm)       | Thread  | Part No    |
| <b>30 x 25</b>        | M8 M/F  | GS3025VD20 |
| <b>40 x 20</b>        | M8 M/M  | GS4020VV23 |
| <b>40 x 30</b>        | M8 M/M  | GS4030VV23 |
| <b>40 x 30</b>        | M10 M/M | GS4030VV25 |
| <b>40 x 40</b>        | M8 F/F  | GS4040DD08 |
| <b>40 x 40</b>        | M8 M/F  | GS4040VD23 |
| <b>40 x 40</b>        | M10 M/F | GS4040VD25 |



# MOTORS & ELECTRICAL

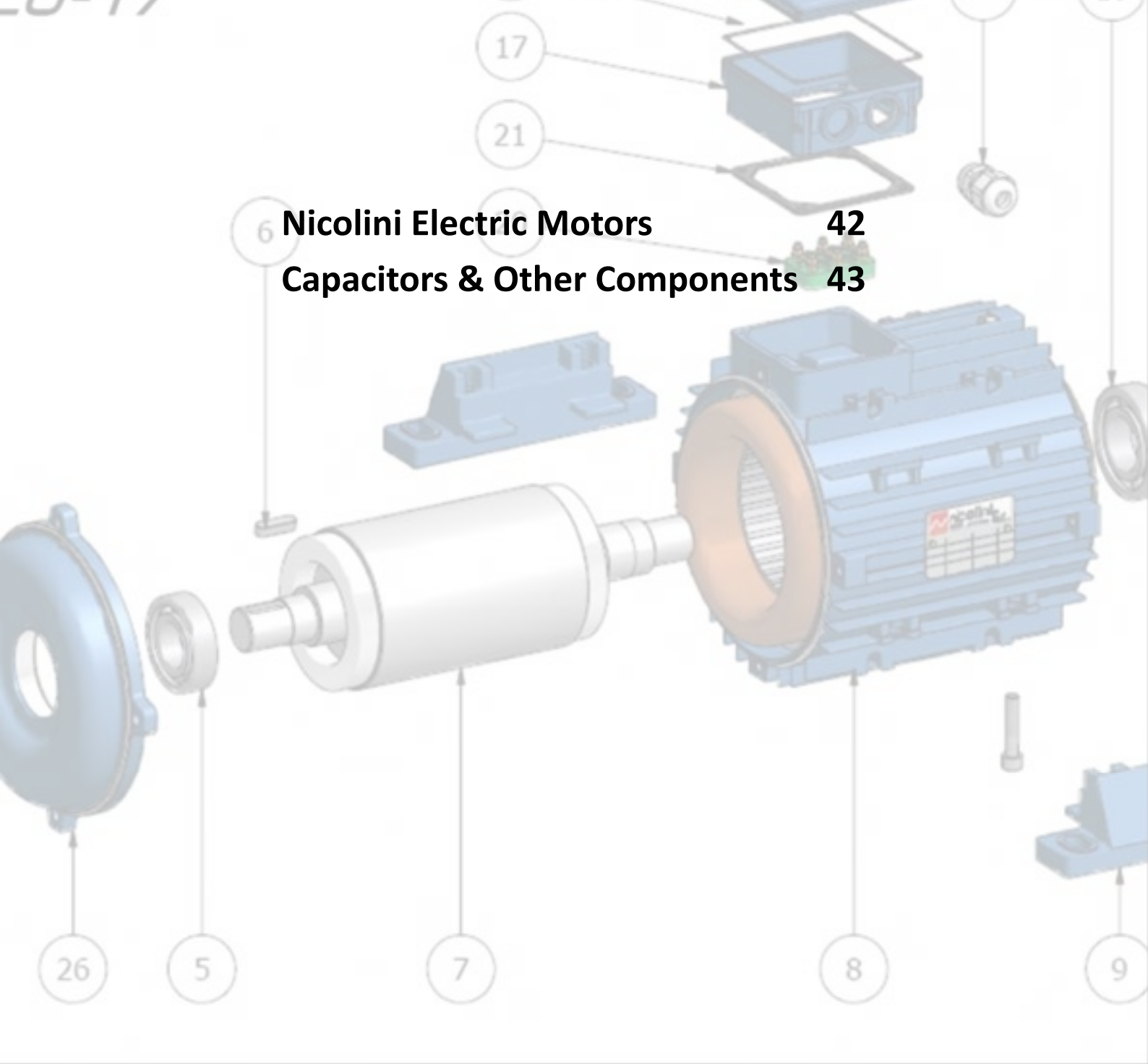

|                               |    |
|-------------------------------|----|
| Nicolini Electric Motors      | 42 |
| Capacitors & Other Components | 43 |

Nicolini Motors - 1450rpm



Nicolini are one of the leading manufacturers of electric motors for high pressure pumps are recognised for their excellent reliability, which is due to the precision of their mechanical processes and the very high grade of materials, such as the Grade A copper used in their construction.

Recently they have designed and developed the HDF double flanged motors which combine the advantages of a standard hollow shaft motor whilst having an inbuilt flange and drive coupling.

All motors listed are 1450rpm, 50Hz and have B3 foot mounts and B14 face



Hollow shaft 240v version



Solid shaft shown with shaft protector



HDF Double flange with drive coupling

| Part No     | KW  | HP  | Voltage | Shaft  | Shaft Ø | Frame Size |
|-------------|-----|-----|---------|--------|---------|------------|
| NIC223H110  | 2.2 | 3   | 110v    | Hollow | 24mm    | 100        |
| NIC223S     | 2.2 | 3   | 240v    | Solid  | 28mm    | 100        |
| NIC223H     | 2.2 | 3   | 240v    | Hollow | 24mm    | 100        |
| NIC304S     | 3   | 4   | 240v    | Solid  | 28mm    | 100        |
| NIC304H     | 3   | 4   | 240v    | Hollow | 24mm    | 100        |
| NIC304H415  | 3   | 4   | 415v    | Hollow | 24mm    | 100        |
| NIC4055S    | 4   | 5.5 | 415v    | Solid  | 28mm    | 100        |
| NIC4055H    | 4   | 5.5 | 415v    | Hollow | 24mm    | 100        |
| NIC4055H112 | 4   | 5.5 | 415v    | Hollow | 24mm    | 112        |
| NIC4055HDF  | 4   | 5.5 | 415v    | HDF    | 24mm    | 112        |
| NIC5575S    | 5.5 | 7.5 | 415v    | Solid  | 28mm    | 112        |
| NIC5575H    | 5.5 | 7.5 | 415v    | Hollow | 24mm    | 112        |
| NIC5575HDF  | 5.5 | 7.5 | 415v    | HDF    | 28mm    | 112        |
| NIC7510H    | 7.5 | 10  | 415v    | Hollow | 24mm    | 132        |
| NIC7510HDF  | 7.5 | 10  | 415v    | HDF    | 24mm    | 132        |
| NIC1115H    | 11  | 15  | 415v    | Hollow | 24mm    | 160        |

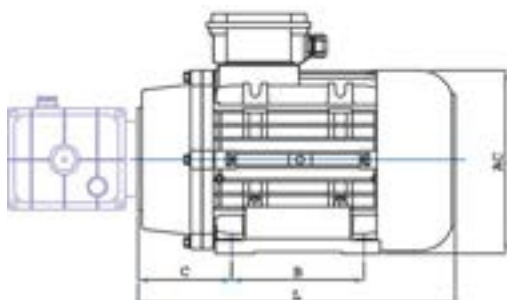

Capacitors



| $\mu$ Rating | Part No  |
|--------------|----------|
| 40           | CAP40MF  |
| 65           | CAP65MF  |
| 80           | CAP80MF  |
| 110          | CAP110MF |



Motor Protection Switches



| Range (Amps) | WIMEX  | WIMEX Housing |
|--------------|--------|---------------|
| 6.3 - 10A    | 901710 | 901730        |
| 10 - 16A     | 901716 |               |
| 16 - 20A     | 901720 |               |
| 20 - 25A     | 901725 |               |

| Range (Amps) | OKN    | OKN Housing |
|--------------|--------|-------------|
| 10 - 16A     | 901516 | 901540      |
| 16 - 22A     | 901522 |             |
| 22 - 27A     | 901527 |             |

16 Amp - 13 Amp Reducers



|                             |                             |
|-----------------------------|-----------------------------|
| 13A Plug x 16A 3 Pin Socket | 13A Socket x 16A 3 Pin Plug |
| GSMLUK                      | GSMUKS                      |





# HOSE ADAPTORS & CONNECTORS



|   |           |
|---|-----------|
| <b>BSP Threaded Adaptors</b>                  | <b>46</b> |
| <b>BSP Sockets &amp; Elbows</b>               | <b>47</b> |
| <b>BSP T &amp; Y Pieces, Plugs &amp; Caps</b> | <b>48</b> |
| <b>K-Lock &amp; M22F Adaptors</b>             | <b>49</b> |
| <b>Other Quick Screw Couplings</b>            | <b>50</b> |
| <b>M22M &amp; Gun Inlet Adaptors</b>          | <b>51</b> |
| <b>Mini &amp; Midi QRC's</b>                  | <b>52</b> |
| <b>Tema, ST45 &amp; ST3100 QRC's</b>          | <b>53</b> |
| <b>Inline &amp; 90° Swivels Couplings</b>     | <b>54</b> |
| <b>Thread Sealants, Seals &amp; Pastes</b>    | <b>55</b> |



QUICK RELEASE  
COUPLINGS

NUTS / PLUGS / CAPS

## HOSE ADAPTORS & CONNECTORS

### Male x Male Adaptors



| Thread      | Male x Male 60° Cone |       |               | Bulkhead Adaptors inc Lock Nut |               | BSP Parallel (P) x<br>BSP Taper (T) | BSP x NPT |
|-------------|----------------------|-------|---------------|--------------------------------|---------------|-------------------------------------|-----------|
|             | Brass                | Steel | 316 Stainless | Steel                          | 316 Stainless | Steel                               | Steel     |
| 1/8" x 1/8" | 57010                | GS495 |               |                                |               |                                     |           |
| 1/8" x 1/4" | 57020                | 57028 | 57029         |                                |               |                                     |           |
| 1/4" x 1/4" | 57040                | 57048 | 57049         | GS028                          |               | GS720                               | GS310     |
| 1/4" x 3/8" | 57050                | 57058 | 57059         |                                |               |                                     |           |
| 1/4" x 1/2" | 57060                | 57068 | 57069         |                                |               |                                     |           |
| 3/8" x 3/8" | 57070                | 57078 | 57079         | GS029                          | GS5031        | GS485                               | GS470     |
| 3/8" x 1/2" | 57080                | 57088 | 57089         |                                |               | GS490                               | GS110     |
| 1/2" x 1/2" | 57090                | 57098 | 57099         | GS130                          | GS5032        | GS400                               | GS115     |
| 1/2" x 3/4" | 57100                | 57108 | 57109         |                                |               |                                     |           |
| 3/4" x 3/4" | 57110                | 57118 |               | GS265                          |               |                                     |           |
| 3/4" x 1"   | 57120                | 57128 |               |                                |               |                                     |           |
| 1" x 1"     | 57130                | 57138 |               |                                |               |                                     |           |

### Male x Female Adaptors



| Male x Female | BSP Male x Female 60° Cone |               | BSP Male x Fixed Female Bushes |       |               | Extension Nipples |               |
|---------------|----------------------------|---------------|--------------------------------|-------|---------------|-------------------|---------------|
|               | Steel                      | 316 Stainless | Brass                          | Steel | 316 Stainless | Brass             | 316 Stainless |
| 1/8" x 1/4"   |                            |               |                                |       |               | 57610             |               |
| 1/4" x 1/8"   |                            |               | 57510                          | 57518 | 57519         |                   |               |
| 1/4" x 1/4"   | GS022                      | GS5010        |                                |       |               | 57620             |               |
| 1/4" x 3/8"   | GS025                      |               |                                |       |               | 57630             | 57639         |
| 1/4" x 1/2"   | GS135                      |               |                                |       |               |                   |               |
| 3/8" x 1/8"   |                            |               | 57520                          | 57528 |               |                   |               |
| 3/8" x 1/4"   | GS023                      | GS5012        | 57530                          | 57538 | 57539         | 57640             |               |
| 3/8" x 3/8"   | GS026                      | GS5013        |                                |       |               | 57650             |               |
| 3/8" x 1/2"   | GS140                      | GS5014        |                                |       |               | 57660             | 57669         |
| 1/2" x 1/4"   |                            |               | 57540                          | 57548 | 57549         |                   |               |
| 1/2" x 3/8"   | GS150                      | GS5016        | 57550                          | 57558 | 57559         |                   |               |
| 1/2" x 1/2"   | GS155                      | GS5017        |                                |       |               | 57680             |               |
| 1/2" x 3/4"   | GS260                      |               |                                |       |               | 57670             |               |
| 3/4" x 3/8"   |                            |               | 57560                          | 57568 |               |                   |               |
| 3/4" x 1/2"   |                            |               | 57570                          | 57578 | 57579         |                   |               |
| 1" x 3/4"     |                            |               | 57580                          |       |               |                   |               |

## HOSE ADAPTORS & CONNECTORS

### BSP Female x Female Adaptors



\* Cylindrical Socket

| Thread      | Female x Female Socket |                     |         |                 | 60° Cone Swivel Nut |               |
|-------------|------------------------|---------------------|---------|-----------------|---------------------|---------------|
|             | Brass                  | Nickel Plated Brass | Steel   | 316 Stainless   | Steel               | 316 Stainless |
| Pressure    | 400 bar                | 50 bar              | 400 bar | 400 or 500bar   | 350 bar             | 400 bar       |
| 1/8" x 1/8" | 51810                  |                     |         |                 |                     |               |
| 1/8" x 1/4" | 51820                  |                     |         |                 |                     |               |
| 1/4" x 1/4" | 51830                  |                     | 51832   | 51839 (500)     | GS020               |               |
| 1/4" x 1/4" |                        |                     |         | 519009* (500)   |                     |               |
| 1/4" x 3/8" | 51860                  |                     |         | 040001023 (400) | GS021               |               |
| 1/4" x 1/2" |                        | 518524              |         |                 |                     |               |
| 3/8" x 3/8" | 51840                  |                     | GS180   | 51849 (400)     | GS024               | GS5023        |
| 3/8" x 1/2" |                        | 518534              |         |                 | GS165               |               |
| 1/2" x 1/2" | 51850                  |                     | GS185   | 51859 (400)     | GS170               |               |
| 3/4" x 3/4" | 51855                  |                     | GS465   |                 |                     |               |

### BSP 90° Elbows



| Thread   | Male x Male Elbow |           |         | Male x Female Elbow |               |         |                |                        |
|----------|-------------------|-----------|---------|---------------------|---------------|---------|----------------|------------------------|
|          | Brass             | N.P Brass | Steel   | Brass               | Brass Compact | Brass   | Steel 60° Cone | 316 Stainless 60° Cone |
| Pressure | 350 bar           | 150 bar   | 350 bar | 300bar              | 250 bar       | 150 bar | 280 bar        | 380 bar                |
| 1/8"     |                   |           |         |                     |               |         |                |                        |
| 1/4"     | 010005440         |           |         | 010005410           | 57210         | 57230   | GS230          |                        |
| 3/8"     | 57745             | 57270     | GS220   | 57700               | 57220         | 57235   | GS235          | GS5051                 |
| 1/2"     |                   | 57280     |         |                     |               | 57236   | GS240          | GS5052                 |
| 3/4"     |                   |           | GS760   |                     |               |         | GS530          |                        |

### BSP 90° Elbows & Other Adaptors



| Thread   | BSP 90° Female Elbows |           |                | Metric Compression Fittings |                  |                 |             |
|----------|-----------------------|-----------|----------------|-----------------------------|------------------|-----------------|-------------|
|          | Brass                 | N.P Brass | Steel 60° Cone | Thread                      | Metric M x BSPTM | Metric M x BSPF | Pipe x BSPM |
| Pressure | 350 bar               | 150 bar   | 350 bar        | 12L x 3/8"                  |                  |                 | 58320       |
| 1/4"     | 57720                 | 57240     | GS245          | M14 x 1/4"                  |                  | 58010           |             |
| 3/8"     | 57730                 | 57250     | GS250          | M14 x 3/8"                  | 58105            |                 |             |
| 1/2"     |                       | 57251     | GS255          | M18 x 1/4"                  | 58150            |                 |             |
|          |                       |           |                | M18 x 3/8"                  | 58160            | 58040           |             |

## HOSE ADAPTORS & CONNECTORS

### BSP Tee Piece Adaptors



|             | Male Equal Tee |         | Equal Female Tee |                |                   |               | Male Leg x F Tee |
|-------------|----------------|---------|------------------|----------------|-------------------|---------------|------------------|
| Thread      | Steel 60° Cone | Brass   | N.P Brass        | Steel 60° Cone | 316 Stainless 60° | 316 Stainless | Compact Brass    |
| Pressure    | 250 bar        | 150 bar | 350 bar          | 250 bar        | 250 bar           | 10 bar        | 250 bar          |
| 1/8" x 1/8" |                |         |                  |                |                   |               | 57300            |
| 1/4" x 1/4" | GS190          |         | 57330            | GS205          |                   | ADP0090       | 57310            |
| 3/8" x 3/8" | GS195          | 57770   | 57332            | GS027          | GS5071            | ADP0091       | 57320            |
| 1/2" x 1/2" | GS200          |         | 57333            | GS210          |                   | ADP0090       |                  |

### BSP Tee Pieces, Y Pieces & Crosses



|          | Female Leg Tee |           | Y Pieces        |                 | 4 Way Cross Piece |
|----------|----------------|-----------|-----------------|-----------------|-------------------|
| Thread   | Brass          | N.P Brass | N.P Brass FxFxM | N.P Brass FxFxF | N.P Brass FxFxFxF |
| Pressure | 150 bar        | 150 bar   | 150 bar         | 150bar          | 150 bar           |
| 1/4"     |                | 57350     |                 | 57400           | 574514            |
| 3/8"     | 57660          | 57360     | 57435           | 57410           |                   |
| 1/2"     |                | 57370     |                 | 57415           |                   |

### BSP Plugs & Caps



|          | Male Plugs    |                          |                           |                |                    | Female Caps    |
|----------|---------------|--------------------------|---------------------------|----------------|--------------------|----------------|
| Thread   | Rimless Brass | Rimmed with Internal Hex | Plated Brass with Hex Nut | Steel 60° Cone | Stainless 60° Cone | Steel 60° Cone |
| Pressure | 250bar        | 250bar                   | 250bar                    | 250bar         | 250bar             | 250 bar        |
| 1/8"     | 57800         | 57801                    |                           | GS330          |                    |                |
| 1/4"     | 57810         | 57815                    | 57815N                    | GS335          | GS5081             | GS360          |
| 3/8"     | 57820         |                          | 57825                     | GS340          |                    | GS365          |
| 1/2"     |               | 57830                    |                           | GS345          |                    | GS370          |
| 3/4"     |               | 57840                    |                           |                |                    |                |



## HOSE ADAPTORS & CONNECTORS

### K-Lock Quick Screw & Convertors

The K-Lock range of adaptors come as standard with a contact activated threadlock. Due to the short threads, this is required to stop any unwanted unscrewing of the connectors when in operation. This means that these adaptors are not designed to be frequently screwed/unscrewed once initially installed.



| Description  | K-Lock x M22M | K-Lock x 3/8" F | K-Lock x 3/8" M | K-Lock x M22M Swivel | K-Lock x 3/8" F Swivel | K-Lock F x K-Lock F |
|--------------|---------------|-----------------|-----------------|----------------------|------------------------|---------------------|
| Max Pressure | 400 bar       | 400 bar         | 400 bar         | 400 bar              | 400 bar                | 400 bar             |
| Part No      | 565681        | 565684          | 565683          | 200301100            | 200301110              | 200247255           |

### ST247 Quick Release System for K-Lock

### ST247 Quick Release System for K-Lock



| TR22 x TR22 Hose Joiner | K-Lock M x 3/8" M | K-Lock M x 1/4" F |
|-------------------------|-------------------|-------------------|
| 400 bar                 | 400 bar           | 300 bar           |
| 56922                   | 010003041         | 010003039         |

| K-Lock F x QRC | QR Probe x 1/4" F | QR Probe x 1/4" M |
|----------------|-------------------|-------------------|
| 300 bar        | 300 bar           | 300 bar           |
| 200247410      | 200247100         | 200247110         |

### M22F x BSP Quick Screw Adaptors + 14mm Nose



| Thread       | ST40 M22F  |           | System 2000 M22F |          | M22F Short |          | ST44 M22F Swivel |           | M22F Stainless Steel |          |
|--------------|------------|-----------|------------------|----------|------------|----------|------------------|-----------|----------------------|----------|
|              | BSP Female | BSP Male  | BSP Female       | BSP Male | BSP Female | BSP Male | BSP Female       | BSP Male  | BSP Female           | BSP Male |
| 1/4"         | 200040500  | 200040510 | 561302           | 561402   | 56020      | 56030    | 56815            | 56800     | 56139                | 56149    |
| 3/8"         | 200040540  | 200040530 | 561502           | 561602   |            |          | 56820            |           | 56159                | 56169    |
| 1/2"         | 56165      | 56166     |                  |          |            |          |                  |           |                      |          |
| NBR O'Ring   | 79030      | 79030     | 79030            | 79030    | 79030      | 79030    | 050000379        | 050000379 |                      |          |
| Viton O'Ring | 79035      | 79035     | 79035            | 79035    | 79035      | 79035    |                  |           | 79035                | 79035    |

## HOSE ADAPTORS & CONNECTORS

### Quick Screw Couplings with Elongated Centres



| Inlet    | M22F Long Centric Nipple | M22M Long Version | M22F Hex Centric | M22M Hex Centric | ST241 - 1/2" F No O-Ring | ST241 - 1/2" M Internal O-Ring |
|----------|--------------------------|-------------------|------------------|------------------|--------------------------|--------------------------------|
| Pressure | 400bar                   | 400bar            | 400bar           | 400bar           | 300bar                   | 300bar                         |
| 1/4" F   | 56131                    | 565251            | 56050            | 56580            | 56607                    | 200241700                      |
| 3/8" F   |                          | 565401            |                  |                  | 56606                    | 200241720                      |
| 1/4" M   |                          |                   |                  |                  | 56609                    | 200241710                      |
| 3/8" M   |                          |                   |                  |                  | 56608                    | 200241730                      |

### Other Quick Screw Couplings



| Inlet    | 1/2" F (ALTO) | 1/2" M (ALTO) | M24 (WAP) | M27 (WAP) | ST740 M24F | ST741 M24M |
|----------|---------------|---------------|-----------|-----------|------------|------------|
| Pressure | 250bar        | 250bar        | 250bar    | 250bar    | 700 bar    | 700 bar    |
| 1/4" F   | 56110         | 56780         |           |           |            | 200741504  |
| 3/8" F   |               |               | 31824     | 31827     | 200740502  | 200741502  |
| 3/8" M   |               |               |           |           | 200740501  | 200741501  |
| 1/2" M   |               |               |           |           | 200740503  | 200741503  |

### 15mm Nose Quick Screw Connectors (LAV style)



| Thread | M22F x BSPF | M22F x BSPM | M22M x BSPF | M22M x BSPM |
|--------|-------------|-------------|-------------|-------------|
| 1/4"   | LAVF14F     | LAVF14M     | LAVM14F     | LAVM14M     |
| 3/8"   | LAVF38F     | LAVF38F     | LAVM38F     | LAVM38M     |

## HOSE ADAPTORS & CONNECTORS

### ST41 M22M x BSP Quick Screw Nipples for 14mm Nose



|        | ST41 M22M  |                     | M22M Long  |                   | M22M Hex Nut for KR | ST41 M22M Stainless Steel |          |
|--------|------------|---------------------|------------|-------------------|---------------------|---------------------------|----------|
| Thread | BSP Female | BSP Male Flat Faced | BSP Female | BSP Male 60° Cone | BSP Female          | BSP Female                | BSP Male |
| 1/4"   | 010001010  | 010000530           | 565251     | 565301            | 56580               | 56529                     | 56539    |
| 3/8"   | 010000540  | 010000550           | 565401     | 565501            |                     | 56549                     | 56559    |
| 1/2"   | 56565      |                     |            |                   |                     |                           | 56569    |

### M22M x M22 Quick Screw Adaptors



| K2000 - M22F x M22M | M22M x M22M | M22M x M22M | M22M x M22M + Rubber Cover | Stainless Steel M22M x M22M |
|---------------------|-------------|-------------|----------------------------|-----------------------------|
| 400bar              | 400bar      | 400bar      | 400bar                     | 500bar                      |
| 56566               | 56920       | 56950       | 56940                      | 56959                       |

### Gun Inlet Connections



| Inlet | Hose Reel Connector (Alto) | Gun Inlet Probe (KAR) <span style="background-color: yellow;">K</span> | 10mm Inlet Pipe 190mm <span style="background-color: yellow;">K</span> | 11mm Stainless Inlet Pipe 145mm <span style="background-color: yellow;">K</span> | 11mm Inlet Pipe 190mm <span style="background-color: yellow;">K</span> | 11mm Stainless Inlet Adaptor & Pin <span style="background-color: yellow;">K</span> | 10mm Inlet Plug <span style="background-color: yellow;">K</span> |
|-------|----------------------------|--|--|--|--|---|--|
| 1/4"M | 200000035                  |  |  |  |  |   |  |
| 3/8"M |                            | 31695191   |  |  |  | 55991138  |  |
| M22M  |                            |  | 3169510  | 3169612  | 3169611  |   | 5599102  |
| Seals | 050001361                  | 050000205  | 79055  | 79057  |  |   |  |

## HOSE ADAPTORS & CONNECTORS

### Mini Quick Release Couplings (Ø11.6mm)



| Thread        | Brass Coupling<br>Female Thread | Stainless Steel Coupling<br>Female Thread | Stainless Steel Coupling<br>Female Thread |
|---------------|---------------------------------|---|---|
| 1/4"          | TPQNC                           | TPQNCSS                                   | 200245500                                 |
| Spare O'Rings | 050000650                       | 050000650                                 | 050000650                                 |



| Thread | Steel Probe<br>Male Thread | Steel Probe<br>Female Thread | Stainless Steel Probe<br>Male Thread | Stainless Steel Probe<br>Female Thread |
|--------|----------------------------|------------------------------|--------------------------------------|--|
| 1/4"   | TPQNN14M                   | TPQNN14F                     | TPQNN14MSS                           | TPQNN14FSS                             |

### Midi Series SP20 Quick Release Couplings (Ø14.8mm)



| Thread        | Brass Coupling<br>Female Thread | Brass Coupling<br>Male Thread | Stainless Steel Coupling<br>Female Thread |
|---------------|---------------------------------|-------------------------------|---|
| 3/8"          | TPQNC38                         | 55020                         | TPQNC38SS                                 |
| Spare O'Rings | MIDIOR                          | MIDIOR                        | MIDIOR                                    |



| Thread | Steel Probe<br>Female Thread | Steel Probe<br>Male Thread | Stainless Probe<br>Female Thread |
|--------|------------------------------|----------------------------|----------------------------------|
| 1/4"   | 55111                        |                            |                                  |
| 3/8"   | TPQNN38F                     | 55120                      | TPQNN38FSS                       |

## HOSE ADAPTORS & CONNECTORS

### TEMA Quick Release Couplings



| Thread | TEMA Complete Set<br>(TEM02 + TEM03) | NRV Complete Set<br>(TEM05 + TEM06) | TEMA Coupling | TEMA Coupling<br>Lockable | TEMA Coupling<br>Lockable + NRV | TEMA Probe<br>* 320bar | TEMA Probe + NRV |
|--------|--------------------------------------|-------------------------------------|---------------|---------------------------|---------------------------------|------------------------|------------------|
| Rating | 350bar, 100°C                        | 350bar, 100°C                       | 350bar, 100°C | 300bar, 100°C             | 350bar, 100°C                   | 350bar, 100°C          | 350bar, 100°C    |
| 3/8" F | TEM01                                | TEM04                               | TEM02         |                           | TEM05                           | TEM03                  | TEM06            |
| 1/2" F |                                      |                                     |               | TEM5010                   |                                 | TEM5020*               |                  |



| TEMA      | Part No (single) |
|-----------|------------------|
| Small NBR | TEM09            |
| Large NBR | TEM08            |

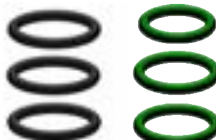

| ST45        | Part No (set of 3) |
|-------------|--------------------|
| EPDM        | 55710411           |
| Green Viton | 55710411G          |

### ST45 High Pressure Quick Release Couplings - Interchangeable with TEMA un-valved range



| Thread   | ST45 Nickel Plated<br>Brass Coupling | ST45 Nickel Plated<br>Coupling inc Cover | ST45 Stainless<br>Coupling | ST45 Stainless<br>Coupling inc Cover | ST45 Stainless<br>Coupling, Cover +<br>Male Thread | Steel Probe   | Stainless Steel<br>Probe |
|----------|--------------------------------------|--|----------------------------|--------------------------------------|--|---------------|--------------------------|
| Pressure | 250bar, 150°C                        | 250bar, 150°C                            | 250bar, 150°C              | 250bar, 150°C                        | 250bar, 150°C                                      | 250bar, 150°C | 250bar, 150°C            |
| 1/4"     |                                      |  |                            |                                      |  |               | 040005482                |
| 3/8"     | 557103                               | 200045505                                | 557109                     | 200045565                            | 200045595  | 557204        | 557209                   |
| 1/2"     |                                      |  | 5571911041                 | 200045555                            |  |               | 55729                    |
| M22F     |                                      |  |                            |                                      |  | 65632B9       |                          |

### ST3100 Stainless Steel Quick Release Couplings



|      | Coupling<br>Female Thread | Coupling + Cover<br>Female Thread | Coupling<br>Male Thread | Coupling + Cover<br>Male Thread | Probe<br>Female Thread | Probe<br>Male Thread | Probe for Moulded<br>Lance |
|------|---------------------------|-----------------------------------|-------------------------|---------------------------------|------------------------|----------------------|----------------------------|
| 1/4" |                           |                                   |                         | 203100652                       | 040005465              |                      | 040005664                  |
| 3/8" | 203100461                 | 203100456                         |                         | 203100475                       | 040005467              | 040005459            |                            |
| 1/2" | 203100460                 | 203100455                         | 203100655               | 203100656                       | 040005461              | 040005662            |                            |



| O'Ring Size  | Singles  |
|--------------|----------|
| 18 x 2mm     | 55150243 |
| 15.1 x 2.7mm | 55150242 |

## HOSE ADAPTORS & CONNECTORS

### Inline Swivels



|               |              |                         |                         |                     |                          |                          |                          |                          |
|---------------|--------------|-------------------------|-------------------------|---------------------|--------------------------|--------------------------|--------------------------|--------------------------|
| Max Temp 90°C | ST300 Brass  | ST300<br>N.P Brass & SS | ST300<br>N.P Brass & SS | ST301<br>Brass & SS | ST303<br>Ball Bearing SS | ST310<br>Stainless Steel | ST310<br>Stainless Steel | ST310<br>Stainless Steel |
| Thread        | 1/4" M/F     | 3/8" M/F                | 1/4" F x 3/8" F         | 1/4" F x 3/8" F     | 1/4" F x 3/8" F          | 3/8" M/F                 | 1/2" M/F                 | 1/4" F x 3/8" F          |
| Rating        | 275bar, 90°C | 275bar, 90°C            | 275bar, 90°C            | 350bar, 90°C        | 400bar, 100°C            | 350bar, 90°C             | 350bar, 90°C             | 350bar, 90°C             |
| Part No       | 200300040    | 200300010               | 200300000               | 200301050           | 200303050                | 200310010                | 200310040                | 200310000                |
| Repair Kit    |              | 200300100               | 200300100               | 200300100           |                          | 200300100                | 200300100                | 200300100                |



|               |                |                          |                    |              |               |               |               |               |
|---------------|----------------|--------------------------|--------------------|--------------|---------------|---------------|---------------|---------------|
| Max Temp 90°C | ST340<br>Brass | ST350<br>Stainless Steel | ST96<br>SS 2000rpm | Brass        | Easywash 365  | Easywash 365  | Easywash 365  | Mosmatic DGS  |
| Thread        | 1/2" M/F       | 3/8" M/F                 | 3/8" M/F           | 3/8" M/F     | 1/4" M/F      | 3/8" M/F      | 1/4" F/F      | 3/8" M/F      |
| Rating        | 250bar, 90°C   | 500bar, 90°C             | 350bar, 100°C      | 220bar, 90°C | 275bar, 120°C | 275bar, 120°C | 275bar, 120°C | 275bar, 120°C |
| Part No       | 200340510      | 200350010                |                    | 56250        | 562391600     | 562391615     | 562391620     | 10830103      |
| Repair Kit    | 200340150      |                          |                    |              |               |               |               |               |

### ST320 & ST322 Stainless Steel Hose Reel Swivels



|               |                 |                 |                 |                 |                 |                 |                 |
|---------------|-----------------|-----------------|-----------------|-----------------|-----------------|-----------------|-----------------|
| Max Temp 90°C | ST320           |                 |                 | ST322           |                 |                 |                 |
| Thread        | 1/4" F x 1/4" M | 3/8" F x 3/8" M | 3/8" F x 3/8" M | 3/8" F x 3/8" M | 1/2" F x 3/8" M | 1/2" F x 1/2" M | 1/2" F x 1/2" M |
| Rating        | 275bar, 90°C    | 275bar, 90°C    | 275bar, 90°C    | 400bar, 90°C    | 300bar, 90°C    | 300bar, 90°C    | 300bar, 90°C    |
| RPM           | 30rpm           | 30rpm           | 30rpm           | 30rpm           | 30rpm           | 30rpm           | 30rpm           |
| Part No       | 200320550       | 200320500       | 200320502       | 200322500       | 200322510       | 200322520       | 200322522       |
| Repair Kit    | 200320490       | 200320490       | 200320490       | 200322490       | 200322490       | 200322490       | 200322490       |

### Other Hose Reel Swivels



|               |               |                 |                 |                 |                 |                 |
|---------------|---------------|-----------------|-----------------|-----------------|-----------------|-----------------|
| Max Temp 90°C | ST322         | Easywash 365    | Easywash 365    | Mosmatic WDG    | R+M Stainless   | Fiacom          |
| Thread        | 1/2" F x M28M | 3/8" F x 1/4" M | 3/8" F x 3/8" M | 3/8" F x 1/4" M | 3/4" F x 3/4" M | 3/8" F x 3/4" M |
| Pressure      | 300bar, 90°C  | 275bar, 90°C    | 275bar, 90°C    | 150bar, 90°C    | 200bar, 90°C    | 400bar, 150°C   |
| Part No       | 200322523     | 562390505       | 562390507       | 7501401         | 7504001         | GS0066B         |
| Repair Kit    | 200322490     |                 |                 |                 | 7504002         |                 |

# HOSE ADAPTORS & CONNECTORS

## Loxéal Liquid Sealants & Threadlocks



Great for permanent assemblies

Great for nozzles

|                  | 83.21<br>High Strength<br>Retainer | 53.14<br>Hyd/Pneumatic<br>Thread Seal | 58.11<br>WRAS Approved<br>Pipe Sealant | 85.86<br>Gas & Potable<br>Water Thread<br>Sealant | 55.03<br>Oil Tolerant<br>Threadlock | 83.54<br>High Torque<br>Release Threadlock | 58.14<br>Liquid Gasket |
|------------------|------------------------------------|---------------------------------------|--|---|-------------------------------------|--|------------------------|
| Liquid Colour    | Green                              | Brown                                 | Yellow                                 | Green   | Blue                                | Green                                      | Orange                 |
| Locking Strength | High                               | Medium                                | Medium                                 | High  | Medium                              | High                                       | Low                    |
| Nm Shear         | 25-35                              | 12-16                                 | 18-22                                  | 15-25   | 17-22                               | 28-35                                      | 5-8                    |
| Temp             | -55 - 175°C                        | -55 - 150°C                           | -55 - 150°C                            | -55 - 200°C                                       | -55 - 150°C                         | -55 - 150°C                                | -55 - 150°C            |
| 50ml             | 95450                              | 9545314050                            | LOX5811                                | 9548586050  | LOX5503                             | LOX8354                                    |                        |
| 75ml             |                                    |                                       |  |   |                                     |  | 9545814075             |
| 250ml            | 95455                              |                                       |  |   |                                     |  |                        |

## Self Centring Bonded Seals



| To Fit Threads | Plated Steel<br>Bonded Seals<br>(Bag of 100) | Plated Steel<br>Bonded seals<br>(single) | Stainless Steel<br>Bonded seals<br>(single) |
|----------------|--|--|---|
| 1/8"           |  | DOW18                                    | DOW19                                       |
| 1/4"           | DOW06100                                     |  | DOW01                                       |
| 3/8"           | DOW07100                                     |  | DOW02                                       |
| 1/2"           | DOW08100                                     |  | DOW03                                       |
| 3/4"           |  | DOW09                                    | DOW04                                       |
| 1"             |  | DOW10                                    | DOW05                                       |

## Other Sealants & Pastes



Lubricant designed for use on stainless steel fittings, to stop them seizing and binding up when being screwed together



Dow Corning 7 is a lubricant and preservative compound. It is ideal for use with metals, plastics & polymers. The compound is heat stable and resistant to oxidation and inert to metals, plastics and organic matter.

Temp range -40°C to +200°C

| 10 Pack PTFE Tape | Seal Grease (50g) | Food Grade Seal Grease (40g) | Anti Seize Paste (250g) | Dow Corning 7 (100g) |
|-------------------|-------------------|------------------------------|-------------------------|----------------------|
| 95410             | 95350             | 95355                        | RPASTE50                | GSSRC                |



# HYGIENE-ULTRA 40

## With Antimicrobial Protection

Our exclusive HYGIENE ULTRA 40 hose comes with the antimicrobial impregnated cover, which stops micro-organisms, such as bacteria, from growing on it's surface.

These 40 bar rated hoses have a 12mm internal bore and are available with HACCP compliant red, blue, yellow and green non marking covers.

Designed specifically for the food processing industry, these hoses are the perfect fit for all foaming, rinsing and sanitising applications.

### Technical Data

|                              | DN12 - Antimicrobial Hose |
|------------------------------|---------------------------|
| Inner Ø (mm)                 | 12.0 +/- 0.6              |
| Outer Ø (mm)                 | 22.0 +/- 0.6              |
| Thickness (mm)               | 5                         |
| Burst Pressure at 23°C (bar) | 190                       |
| Burst Pressure at 70°C (bar) | 105                       |
| Bending Diameter (mm)        | 84                        |
| Working Temperature (°C)     | -15 to +70                |
| Weight (g/m)                 | 329                       |



(EU) No10/2011

### Hose Construction

|                    |                             |
|--------------------|-----------------------------|
| 1st Inner Layer    | Grey Heat Resistant PVC     |
| 2nd Inner Layer    | Black PVC                   |
| Reinforcement 1    | Polyester Braid             |
| Intermediary layer | Black PVC                   |
| Reinforcement 2    | Polyester Braid             |
| Exterior Cover     | Foodgrade Antimicrobial PVC |







## **HIGH PRESSURE HOSES & FITTINGS**

|  |           |
|--|-----------|
| <b>Smooth Cover Hoses</b>                  | <b>58</b> |
| <b>Wrapped Cover Hoses</b>                 | <b>59</b> |
| <b>Hoses to Suit Karcher &amp; Nilfisk</b> | <b>60</b> |
| <b>Hygiene Ultra</b>                       | <b>61</b> |
| <b>Other Food Grade Hoses</b>              | <b>62</b> |
| <b>Loose Hose</b>                          | <b>63</b> |
| <b>Bend Restrictors</b>                    | <b>64</b> |
| <b>Ferrules</b>                            | <b>65</b> |
| <b>BSP &amp; M22F Hose Inserts</b>         | <b>66</b> |
| <b>Other Hose Inserts &amp; Protection</b> | <b>67</b> |

## HIGH PRESSURE HOSES

### Smooth Cover Hoses with BSP Threads



| Hose Type                     | DN | Mtr | 1/4" M    | 1/4" F    | 3/8" M    | 3/8" M    |
|-------------------------------|----|-----|-----------|-----------|-----------|-----------|
| Polya, 160 bar, 100°C         | 6  | 8m  | 460042208 |           |           |           |
| Flexy<br>300 bar<br>100°C     | 6  | 10m |           | 390052210 | 390044210 |           |
|                               |    | 15m |           | 390052215 | 390044215 |           |
|                               |    | 20m |           | 390052220 |           |           |
| Twin Wire<br>400 bar<br>150°C | 8  | 10m |           |           |           | 346644610 |
|                               |    | 15m |           |           |           | 346644615 |
|                               |    | 20m |           |           |           | 346644620 |
| Twin Wire<br>400 bar<br>150°C | 10 | 10m |           |           |           | 356644610 |
|                               |    | 15m |           |           |           | 356644615 |
|                               |    | 20m |           |           |           | 356644620 |

### Carwash Comfort Hoses



| Hose Type                          | DN | Mtr  | 1/4" F     | 3/8" F     | M22F x 3/8" M | M22F x 3/8" M |
|------------------------------------|----|------|------------|------------|---------------|---------------|
| Carwash Comfort<br>200 bar<br>60°C | 6  | 4m   |            | 461054604  |               |               |
|                                    |    | 4.2m | 4610526042 |            |               |               |
|                                    |    | 4.7m |            | 4610546047 |               |               |
|                                    |    | 5m   |            | 461054605  |               |               |
|                                    |    | 10m  |            | 461054610  | 461003310     | 463003310     |
|                                    |    | 15m  |            |            | 461003315     | 463003315     |
|                                    |    | 20m  |            |            | 461003320     | 463003320     |

### Special Application Smooth Cover Hoses



#### EasyFarm 365+

Especially designed for the agricultural market. The Thermoplastic elastomer cover allows the hose to be used in areas with rough flooring. Cover is also oil, ozone & UV resistant. Brass plated wire braid for high stability.

| Hose Type                       | DN | Mtr | 3/8" M x 3/8" F |
|---------------------------------|----|-----|-----------------|
| EasyFarm 365+<br>275 bar, 120°C | 10 | 15m | 35420155815     |
|                                 |    | 20m | 35420155820     |
|                                 |    | 25m | 35420155825     |
|                                 |    | 30m | 35420155830     |



#### GreyFlex Smooth Cover

Ideal for use in the food and drink industry due to its non marking, stain resistant cover and stainless steel ends. Thermoplastic elastomer cover allows for use on rough ground, and is also grease, oil, UV & ozone resistant. Brass plated steel braid for extremely high stability

| Hose Type                  | DN | Mtr | 3/8" F x 3/8" F | 3/8" M x 3/8" F |
|----------------------------|----|-----|-----------------|-----------------|
| GreyFlex<br>275 bar, 120°C | 10 | 15m | 352201545159    | 352201555159    |

## HIGH PRESSURE HOSES

### Wrapped Cover Hoses with BSP Threads



| Hose Type                       | DN | Mtr | 1/4" M    | 3/8" F    | 3/8" M    | 3/8" M x M22F |  |
|---------------------------------|----|-----|-----------|-----------|-----------|---------------|--|
| Single Wire<br>210 bar<br>150°C | 6  | 10m | 330142310 |           | 330144310 |               |  |
|                                 |    | 15m |           |           | 330144315 |               |  |
|                                 | 8  | 10m |           | 340154310 |           |               |  |
|                                 | 10 | 10m |           |           |           | 350103310     |  |
| Twin Wire<br>400 bar<br>150°C   | 8  | 2m  |           | 345954302 |           |               |  |
|                                 |    | 10m |           | 345954310 | 345944310 |               |  |
|                                 |    | 15m |           | 345954315 | 345944315 |               |  |
|                                 |    | 20m |           | 345954320 | 345944320 |               |  |
|                                 |    | 30m |           | 345954330 | 345944330 |               |  |
|                                 | 10 | 2m  |           | 355954302 |           |               |  |
|                                 |    | 10m |           | 355954310 | 355944310 | 355103310     |  |
|                                 |    | 15m |           | 355954315 | 355944315 | 355103315     |  |
|                                 |    | 20m |           | 355954320 | 355944320 | 355103320     |  |
|                                 |    | 30m |           | 355954330 | 355944330 |               |  |

### Coloured Wrapped Cover Hoses



| Hose Type                       | DN | Mtr  | 1/4" F     | 1/4" M     | 3/8" M    | M22F      | 3/8" M    |
|---------------------------------|----|------|------------|------------|-----------|-----------|-----------|
| Single Wire<br>210 bar<br>150°C | 6  | 4.2m | 3311528042 |            |           |           |           |
|                                 |    | 5m   | 331152805  |            |           |           |           |
|                                 |    | 7.5m |            | 3311426075 |           |           |           |
|                                 |    | 15m  |            | 331142615  |           |           |           |
| Single Wire<br>315 bar, 150°C   | 8  | 15m  |            |            |           | 344100715 |           |
|                                 |    | 20m  |            |            |           | 344100720 |           |
| Twin Wire<br>400 bar, 150°C     | 10 | 20   |            |            | 380144720 |           |           |
|                                 |    | 30   |            |            |           |           | 381144430 |

## HIGH PRESSURE HOSES

### Wrapped Cover Hoses to fit M22, Karcher & Nilfisk Machines



| Hose Type                       | DN | Mtr | M22F       | M22F      | M22F - 11mm | M22F - 11mm | 11mm - 11mm | Ø13.9 - 3/8" M | Ø13.9 - 8mm |
|---------------------------------|----|-----|------------|-----------|-------------|-------------|-------------|----------------|-------------|
| Single Wire<br>210 bar<br>150°C | 6  | 10m |            |           |             | 330111310   |             |                | 3301102810  |
|                                 |    | 15m |            |           |             |             | 330136815   | 3301100815     | 3301102815  |
|                                 | 8  | 10m | 340100310  |           | 340111410   |             |             |                |             |
|                                 | 10 | 10m |            | 350100410 |             |             |             |                |             |
| Twin Wire<br>400 bar<br>150°C   | 8  | 10m |            |           | 345111410   |             |             |                |             |
|                                 |    | 15m |            |           | 345111415   |             |             |                |             |
|                                 |    | 20m | 345100320  |           |             |             |             |                |             |
|                                 | 10 | 10m | 355100310  |           |             |             |             |                |             |
| Twin Wire<br>500 bar<br>150°C   | 10 | 10m | 3581003109 |           |             |             |             |                |             |
|                                 |    | 20m | 3581003209 |           |             |             |             |                |             |
|                                 |    | 30m | 3581003309 |           |             |             |             |                |             |

### Smooth Cover Hoses to suit Karcher



| Hose Type              | DN | Mtr | M22F - M22F | M22F - 11mm | M22F - 11mm | M22F - 1/4" F | 8.8mm - 8.8mm |
|------------------------|----|-----|-------------|-------------|-------------|---------------|---------------|
| Flexy<br>300bar, 100°C | 6  | 8m  |             |             |             |               |               |
|                        |    | 10m | 3900003210  |             |             | 390012210     | 3900104210    |
|                        |    | 20m | 3900003220  |             |             |               |               |
| 1 Wire, 210 bar, 150°C | 8  | 10m |             | 3406113210  |             |               |               |
|                        |    | 15m |             |             | 340611415   |               |               |
|                        |    | 20m |             |             | 340611420   |               |               |
| 2 Wire, 400 bar, 150°C | 8  | 10m |             |             | 345611410   |               |               |

### Smooth Cover Hoses to fit Nilfisk/Alto, Kranzle & Lavorwash



| Hose Type               | DN | Mtr | 1/2" F - 8mm | Ø13.9mm - 3/8" M | M22F x M14F | M22F x M22F (7.9mm) | M22F (15mm) - 1/4" F |
|-------------------------|----|-----|--------------|------------------|-------------|---------------------|----------------------|
| Polya<br>160 bar, 60°C  | 6  | 8m  |              |                  |             |                     | 460089308            |
|                         |    | 10m |              |                  |             |                     | 460089310            |
| Flexy<br>300 bar, 100°C | 6  | 10m | 390033210    |                  |             |                     | LAV102214            |
|                         |    | 15m |              | 3900100815       | 390007815   | 3900133815          |                      |

# HIGH PRESSURE HOSES



## Hygiene Ultra - with Antimicrobial Cover. DN12 40bar, 70°C

Hygiene Ultra is a 40 bar rated hose, which has an antimicrobial impregnated cover. Specifically designed for the food processing industry, this hose is perfect for both foam, rinse and sanitising applications.



|     | Loose Hose | 1/2" F  | 1/2" M/F | 1/2" M  | Loose Hose | 1/2" F  | 1/2" M/F | 1/2" M  |
|-----|------------|---------|----------|---------|------------|---------|----------|---------|
|     | HYG40B     |         |          |         | HYG40G     |         |          |         |
| 10m |            | HUB10FF | HUB10MF  | HUB10MM |            | HUG10FF | HUG10MF  | HUG10MM |
| 15m |            | HUB15FF | HUB15MF  | HUB15MM |            | HUG15FF | HUG15MF  | HUG15MM |
| 20m |            | HUB20FF | HUB20MF  | HUB20MM |            | HUG20FF | HUG20MF  | HUG20MM |
| 25m |            | HUB25FF | HUB25MF  | HUB25MM |            | HUG25FF | HUG25MF  | HUG25MM |
| 30m |            | HUB30FF | HUB30MF  | HUB30MM |            | HUG30FF | HUG30MF  | HUG30MM |

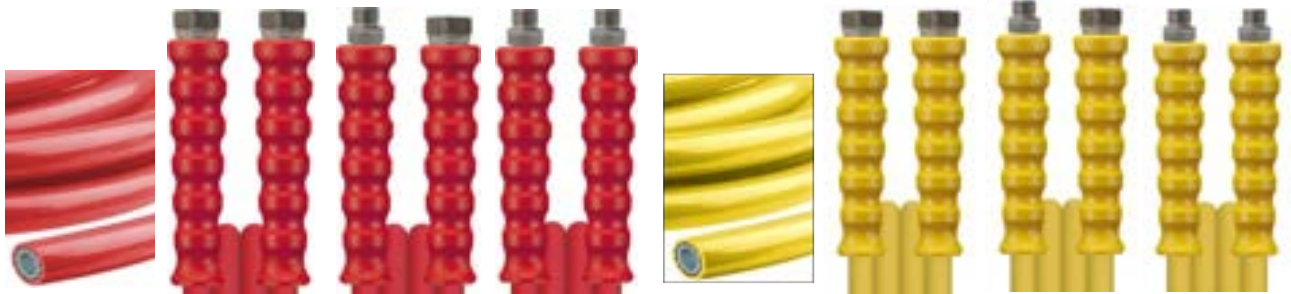

|     | Loose Hose | 1/2" F  | 1/2" M/F | 1/2" M  | Loose Hose | 1/2" F  | 1/2" M/F | 1/2" M  |
|-----|------------|---------|----------|---------|------------|---------|----------|---------|
|     | HYG40R     |         |          |         | HYG40Y     |         |          |         |
| 10m |            | HUR10FF | HUR10MF  | HUR10MM |            | HUY10FF | HUY10MF  | HUY10MM |
| 15m |            | HUR15FF | HUR15MF  | HUR15MM |            | HUY15FF | HUY15MF  | HUY15MM |
| 20m |            | HUR20FF | HUR20MF  | HUR20MM |            | HUY20FF | HUY20MF  | HUY20MM |
| 25m |            | HUR25FF | HUR25MF  | HUR25MM |            | HUY25FF | HUY25MF  | HUY25MM |
| 30m |            | HUR30FF | HUR30MF  | HUR30MM |            | HUY30FF | HUY30MF  | HUY30MM |

## PURClean365+ 100 DN12, 18bar, 100°C

Industrial foam application hose according to (EC)2002/72, 10/2011, (EC)1935/2004 and 2023/2006 for use within the food industry. Suitable for contact with foodstuffs. It has a smooth cover with 1 rot proof textile braid



|     | Loose Hose | 1/2" F     | 1/2" M     |
|-----|------------|------------|------------|
|     | 30366100   |            |            |
| 10m |            | 4770566109 | 4770466109 |
| 15m |            | 4770566159 | 4770466159 |
| 20m |            | 4770566209 | 4770466209 |
| 25m |            | 4770566259 | 4770466259 |
| 30m |            | 4770566309 | 4770466309 |

## HIGH PRESSURE HOSES



### FoodJet 1500

Foodjet 1500 is a yellow covered high pressure hose (DIN EN854) which is particularly resistant to animal & poultry fats. Ideal for use in the cleaning of poultry sheds, and poultry processing environments.  
Max 125bar, 150°C

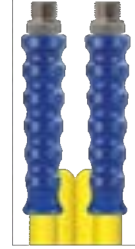

|     | Loose Hose | 1/2" F      | 1/2" M/F    | 1/2" M      |
|-----|------------|-------------|-------------|-------------|
|     | 303601500  |             |             |             |
| 10m |            | 49044566109 | 49044576109 | 49044466109 |
| 15m |            | 49044566159 | 49044576159 | 49044466159 |
| 20m |            | 49044566209 | 49044576209 | 49044466209 |
| 25m |            | 49044566259 | 49044576259 | 49044466259 |
| 30m |            | 49044566309 | 49044576309 | 49044466309 |



### FoodJet

Foodjet is a blue high pressure hose (DIN EN854) which is particularly resistant to animal & poultry fats. Ideal for use in the cleaning of poultry sheds, a poultry processing environments.  
Max 80bar, 150°C



|     | Loose Hose | 1/2" F     | 1/2" M/F   | 1/2" M     |
|-----|------------|------------|------------|------------|
|     | 30360      |            |            |            |
| 10m |            | 4900560109 | 4900576109 | 4900460109 |
| 15m |            | 4900560159 | 4900576159 | 4900460159 |
| 20m |            | 4900560209 | 4900576209 | 4900460209 |
| 25m |            | 4900560259 | 4900576259 | 4900460259 |
| 30m |            | 4900560309 | 4900576309 | 4900460309 |



### Blufood

Blufood is a food grade hose according to (EC) 2002/72, (EU) 10/2011, (EG)1935/2004 & (EG) 2023/2006. Designed for industrial foam applications.  
Max 50bar, 70°C



|     | Loose Hose | 1/2" F     | 1/2" M     |
|-----|------------|------------|------------|
|     | 30360      |            |            |
| 10m |            | 4750566109 | 4750466109 |
| 15m |            | 4750566159 | 4750466159 |
| 20m |            | 4750566209 | 4750466209 |
| 25m |            | 4750566259 | 4750466259 |
| 30m |            | 4750566309 | 4750466309 |

## HIGH PRESSURE HOSES

### DN6 High Pressure Loose Hose



| Size           | DN6           |                 |         |         |         |         |                |                |
|----------------|---------------|-----------------|---------|---------|---------|---------|----------------|----------------|
| Spec           | 160 bar, 65°C | 200 bar, 60°C   |         |         |         |         | 210 bar, 150°C | 400 bar, 150°C |
| Hose Type      | Polya         | Carwash Comfort |         |         |         |         | 1SN            | 2SN            |
| Colour         | Black         | Blue            | Red     | Grey    | Green   | Yellow  | Blue           | Black          |
| Cover          | Smooth        | Smooth          | Smooth  | Smooth  | Smooth  | Smooth  | Wrapped        | Wrapped        |
| Part No        | 30001         | 3001006         | 3001206 | 3001106 | 3001406 | 3001506 | 30107          | 30102          |
| Ferrule to Fit | 31020         | 31020           | 31020   | 31020   | 31020   | 31020   | 31200          | 31200          |

### DN8, 10 & 12 High Pressure Loose Hose

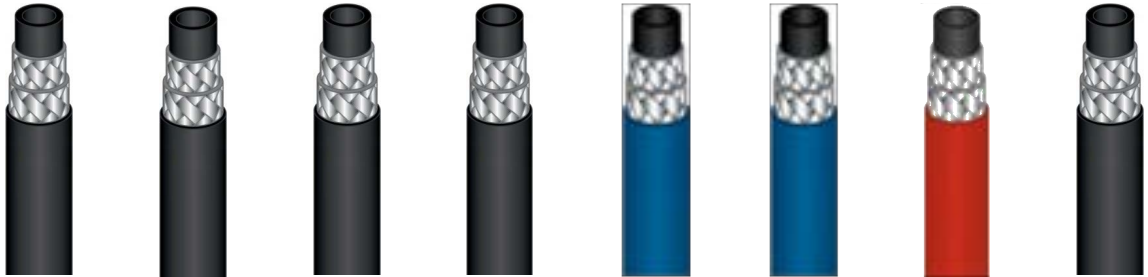

| Size           | DN8            | DN10           |                |                |                |                |                | DN12           |
|----------------|----------------|----------------|----------------|----------------|----------------|----------------|----------------|----------------|
| Spec           | 400 bar, 150°C | 330 bar, 150°C | 400 bar, 150°C | 400 bar, 150°C | 330 bar, 150°C | 400 bar, 150°C | 500 bar, 150°C | 300 bar, 150°C |
| Hose Type      | 2SN            | 2ST            | 2SN            | 2SN            | 2ST            | 2SN            | 2SC            | 2SN            |
| Colour         | Black          | Black          | Black          | Black          | Blue           | Blue           | Red            | Black          |
| OD             | 14.5mm         | 21.4mm         | 18.9mm         | 18.9mm         | 21.4mm         | 18.9mm         | 17.7mm         | 20mm           |
| Cover          | Wrapped        | Thick Wrapped  | Wrapped        | Smooth         | Thick Wrapped  | Smooth         | Wrapped        | Wrapped        |
| Part No        | 30153          | 30235          | 30253          | 30252          | 30236          | 302653         | 30256          | 30281          |
| Ferrule to Fit | 31220          | 31320          | 31320          | 31320          | 31320          | 31320          | 31310          | 31330          |

### DN12 Food Grade Loose Hose



| Size           | DN12          |   |        |        |        |        |             |              |               |
|----------------|---------------|---|--------|--------|--------|--------|-------------|--------------|---------------|
| Spec           | 18 bar, 100°C | 40 bar, 70°C                              |        |        |        |        | 50bar, 70°C | 80bar, 150°C | 125bar, 150°C |
| Hose Type      | PureClean 100 | Hygiene Ultra 40 with Antimicrobial Cover |        |        |        |        | Blufood     | Foodjet      | Foodjet 1500  |
| Colour         | Blue          | Blue                                      | Red    | Green  | Yellow | Blue   | Blue        | Yellow       |               |
| OD             | 21.6mm        | 22mm                                      | 22mm   | 22mm   | 22mm   | 22mm   | 19.7mm      | 21.8mm       |               |
| Cover          | Smooth        | Smooth                                    | Smooth | Smooth | Smooth | Smooth | Smooth      | Smooth       |               |
| Part No        | 30366100      | HYG40B                                    | HYG40R | HYG40G | HYG40Y | 30370  | 30360       | 303601500    |               |
| Ferrule to Fit | 313329        | 313329                                    | 313329 | 313329 | 313329 | 313329 | 313319      | 313301       |               |

## Plastic Compound Bend Restrictors



| DN | ∅      | Black  | TecPro Hygiene Branded Blue | Blue   | TecPro Hygiene Branded Red | Red     | Yellow | Green     |
|----|--------|--------|-----------------------------|--------|----------------------------|---------|--------|-----------|
| 6  | 15.5mm | 308505 |                             | 308515 |                            |         |        |           |
| 8  | 19.5mm | 308605 |                             | 309055 |                            | 308855  | 308805 |           |
| 10 | 20.5mm | 308705 |                             | 309155 |                            | 308955  | 308905 |           |
| 12 | 23.5mm | 308765 |                             | 309165 |                            | GS12RBB | 309185 |           |
| 12 | 23.5mm |        | 30916601                    |        | 30917502                   |         |        | 020000719 |

## Elastomer Bend Restrictors



| DN | ∅ 1    | ∅ 2    | Black | Blue  | Black | Grey  | Blue  | Yellow |
|----|--------|--------|-------|-------|-------|-------|-------|--------|
| 6  | 15.1mm | 15.5mm | 30850 | 30851 |       |       |       |        |
| 8  | 15.6mm | 18.2mm |       |       | 30860 | 30900 | 30905 | 30880  |
| 10 | 17.9mm | 20.5mm |       |       | 30870 |       | 30915 | 30890  |
| 12 | 22.5mm | 25.0mm |       |       |       |       | 30916 |        |

## Plastic Bend Restrictors



| DN | ∅      | Black | Black Spiral | Blue Spiral | Red Spiral | DN | K Gun Inlets |
|----|--------|-------|--------------|-------------|------------|----|--------------|
| 6  | 13.2mm |       | 30855        | 308551      | 308552     | 6  | 3169606      |
| 6  | 13.5mm | 30852 |              |             |            | 8  | 3169608      |



## HIGH PRESSURE HOSES

### Ferrules



| Hose Type                  | Skive/<br>No Skive | Ø      | Length | DN6    | DN8    | DN10  |                 | DN12            |
|----------------------------|--------------------|--------|--------|--------|--------|-------|-----------------|-----------------|
|                            |                    |        |        | Steel  | Steel  | Steel | Stainless Steel | Stainless Steel |
| Plastic R7                 | NS                 | 13.3mm | 25mm   | 31020  |        |       |                 |                 |
| Carwash Comfort            | NS                 | 13.3mm | 25mm   | 31020  |        |       |                 |                 |
| Single Wire                | S                  | 12.3mm | 31mm   | 31205  |        |       |                 |                 |
|                            | S                  | 13.2mm | 30mm   | 31200  |        |       |                 |                 |
|                            | S                  | 14mm   | 31mm   |        | 31210  |       |                 |                 |
|                            | NS                 | 14.4mm | 31mm   | 312001 |        |       |                 |                 |
|                            | NS                 | 16mm   | 30mm   |        | 312101 |       |                 |                 |
|                            | S                  | 16.6mm | 32mm   |        |        | 31310 | 31319           |                 |
|                            | S                  | 19.4mm | 34mm   |        |        |       |                 | 31339           |
| Twin Wire<br>Wrapped Cover | NS                 | 22.7mm | 34mm   |        |        |       |                 | 313319          |
|                            | S                  | 14.2mm | 30mm   | 31204  |        |       |                 |                 |
|                            | S                  | 15.7mm | 30mm   |        | 31220  |       |                 |                 |
| Twin Wire<br>Smooth Cover  | S                  | 18mm   | 32mm   |        |        | 31320 | 31329           | 31339           |
|                            | S                  | 13.2mm | 30mm   | 31200  |        |       |                 |                 |
|                            | S                  | 14mm   | 31mm   |        | 31210  |       |                 |                 |
| Hygiene Ultra              | S                  | 16.6mm | 32mm   |        |        | 31310 | 31319           |                 |
|                            | NS                 | 25.1mm | 34mm   |        |        |       |                 | 313329          |
| BluFood/Pureclean          | NS                 | 25.1mm | 34mm   |        |        |       |                 | 313329          |
| Foodjet                    | NS                 | 22.7mm | 34mm   |        |        |       |                 | 313319          |

### BluFood All in One Fittings



| Thread | Ferrule & BSP Female<br>Thread Stainless Steel | Ferrule & BSP Male Thread<br>Stainless Steel | Re-useable Ferrule & BSP<br>Female Stainless Steel<br>(60° Cone) | Re-useable Ferrule & BSP<br>Flat Faced Female Stainless<br>Steel | Re-useable Ferrule & BSP<br>Male Stainless Steel |
|--------|--|--|--|--|--|
| DN12   | Max 150bar                                     | Max 150bar                                   | Max 50bar  | Max 50bar  | Max 50bar  |
| 1/2"   | 3164295  | 315665                                       | 329012129  | 329112129  | 329312129  |

# HIGH PRESSURE HOSES

## BSP Hose Inserts



| Thread | Ø Hose Tail | Female Thread<br>60° Cone |                 | Flat Faced Fixed<br>Female | Female Swept 90° | Male Thread<br>60° Cone |                 | Flat Faced Male<br>Thread |
|--------|-------------|---------------------------|-----------------|----------------------------|------------------|-------------------------|-----------------|---------------------------|
|        |             | Z.P Steel                 | Stainless Steel | Stainless Steel            | Z.P Steel        | Z.P Steel               | Stainless Steel | Brass                     |
| 1/8"   | 6mm         |                           |                 |                            |                  |                         |                 | 31506                     |
| 1/4"   | 6mm         | 31610                     | 31619           | 31479                      | 31611            | 31520                   | 31529           | 31500                     |
| 3/8"   | 6mm         | 31615                     | 31616           |                            |                  | 31546                   |                 |                           |
| M14    | 6mm         | 31646                     |                 |                            |                  |                         |                 |                           |
| 3/8"   | 8mm         | 31620                     | 31629           |                            |                  | 31550                   |                 |                           |
| 3/8"   | 10mm        | 31630                     | 31625           |                            | 31631            | 31560                   | 31569           |                           |
| 1/2"   | 12mm        |                           | 316429          |                            |                  |                         | 31566           |                           |

## Swivel Nut Hose Fittings



| DN        | 14mm Nose Hose Inserts |           | M22F Nuts for 14mm Nose Inserts |       |       | M22F Long Nut |
|-----------|------------------------|-----------|---------------------------------|-------|-------|---------------|
|           | Z.P Steel              | Stainless | Black                           | Red   | Blue  | Black         |
| 6mm       | 100001942              |           |                                 |       |       |               |
| 8mm       | 100001940              |           |                                 |       |       |               |
| 10mm      | 100001944              | 040001944 |                                 |       |       |               |
| Brass     |                        |           | 31920                           | 31926 | 31925 | 319231        |
| Stainless |                        |           | 319209                          |       |       |               |
| O'Ring    | 79010                  | 79020     |                                 |       |       |               |

## Other M22F Hose Inserts



| DN   | M22F x 14mm Nose | M22F Swept 90°, 14mm Nose | M22F x 14.88mm Nose |
|------|------------------|---------------------------|---------------------|
| 6mm  | 3169022          | 31702                     | 317606              |
| 8mm  | 3170022          | 31701                     | 317608              |
| 10mm |                  | 31703                     |                     |

## HIGH PRESSURE HOSES

### To suit Karcher Hose Tails



|           | 10mm Insert | Brass 10mm | 10mm Insert | 10mm Swivel | 11mm Swivel | Brass Swivel | Brass Fixed |
|-----------|-------------|------------|-------------|-------------|-------------|--------------|-------------|
| 6mm       | 31695       | 3169516    | 3169518     | 31693       | 31694       | 3169519      | 200000092   |
| 8mm       |             |            |             |             | 31696       | 316961       |             |
| O'Ring    | 79055       | 79055      | 79055       | 79055       | 79057       | 050000205    | 050000205   |
| Back Ring | 79058       |            | 79058       | 79058       | 79059       |              |             |

### KEW/Alto/Nilfisk & Other Hose Tails



| DN   | 1/2" F Blue KW | 8mm Brass Plug | For X-TRA machines | M22F for Kranzle | Hose Joiner |
|------|----------------|----------------|--------------------|------------------|-------------|
| 6mm  | 3169012        | 3175206        | 3175216            | 317062209        | 318506      |
| 8mm  |                |                |                    |                  | 318508      |
| 10mm |                |                |                    |                  | 318510      |

### Hose Protection

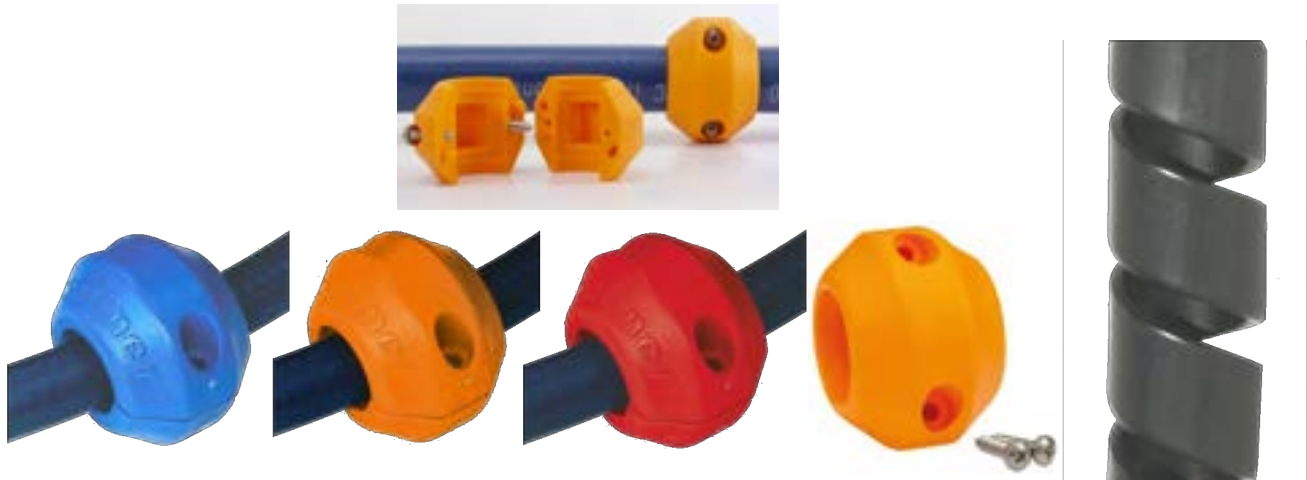

| Pack Size | Blue Hose Ball | Orange Hose Ball | Red Hose Ball | Orange Superball | 20m x Plastic Spiral Hose Protection |
|-----------|----------------|------------------|---------------|------------------|--------------------------------------|
| Ø OD      | 12mm           | 15.8mm           | 17.5mm        | 19mm             | Ø = 16-20mm                          |
| Single    | 020003313      | 020003312        | 020003311     |                  | HOSEGUARD                            |
| 24        | 329191240      | 329192240        | 329193240     | 329190240        |                                      |
| 37        | 329191370      |                  | 329193370     | 329190370        |                                      |
| 49        | 329191490      |                  | 329193490     | 329190490        |                                      |





# SEWER & DRAIN CLEANING

|   |           |
|---|-----------|
| <b>Standard Drain Cleaning Nozzles</b>      | <b>70</b> |
| <b>Male Thread, Silt &amp; Turbo Heads</b>  | <b>71</b> |
| <b>Cylinder &amp; Milling Style</b>         | <b>72</b> |
| <b>Hydro Excavation &amp; Nozzle Spares</b> | <b>73</b> |
| <b>Drain &amp; Sewer Hoses</b>              | <b>74</b> |
| <b>Foot Control Valves</b>                  | <b>75</b> |

# SEWER & DRAIN CLEANING EQUIPMENT

## Drain Cleaning Nozzles

Rear Facing Jets Only

With Forward Facing Jet for Unblocking

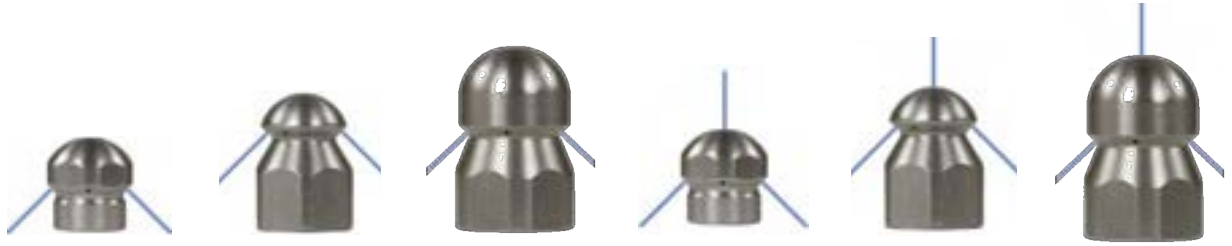

| Nozzle Size | 1/8" F             | 1/4" F             | 3/8" F             | 1/8" F             | 1/4" F             | 3/8" F             |
|-------------|--------------------|--------------------|--------------------|--------------------|--------------------|--------------------|
| Dimensions  | Ø = 15mm, L = 16mm | Ø = 19mm, L = 29mm | Ø = 24mm, L = 35mm | Ø = 15mm, L = 16mm | Ø = 19mm, L = 29mm | Ø = 24mm, L = 35mm |
| 035         | 65001              | 65105              |                    |                    |                    |                    |
| 04          | 65005              | 65104              |                    | 122370170          | 65114              | 65188              |
| 045         | 65000              | 65100              |                    |                    | 65112              |                    |
| 05          |                    | 65108              |                    | 65060              | 65113              |                    |
| 055         | 65009              | 65116              |                    | 65050              | 65115              | 65187              |
| 06          | 65010              | 65110              |                    | 65055              | 65118              |                    |
| 065         |                    |                    |                    | 65056              |                    | 65189              |
| 07          |                    |                    | 65184              |                    |                    |                    |
| 075         |                    |                    |                    | 65020              | 65120              |                    |
| 08          |                    |                    |                    |                    |                    | 65186              |
| 09          | 65040              | 65140              |                    |                    | 65125              |                    |
| 10          |                    |                    |                    | 65030              | 65130              | 65185              |
| 11          |                    |                    |                    |                    | 65146              |                    |
| 12          |                    | 65148              |                    |                    |                    |                    |
| Weight      | 8g                 | 18g                | 38g                | 6g                 | 16g                | 38g                |

## Rotating Drain Cleaning Nozzles



| Nozzle Size | Mini 1/8" F        | 1/8" F             | 1/4" F             | 3/8" F             | 3/8" F with Forward Jet |
|-------------|--------------------|--------------------|--------------------|--------------------|-------------------------|
| Dimensions  | Ø = 12mm, L = 25mm | Ø = 19mm, L = 35mm | Ø = 19mm, L = 35mm | Ø = 24mm, L = 39mm | Ø = 24mm, L = 42mm      |
| 04          |                    |                    | 200049794          | 200049860          |                         |
| 045         |                    | 200049825          | 200049795          | 200049870          |                         |
| 05          | 200049950          | 200049830          | 200049800          | 200049880          |                         |
| 055         |                    | 200049835          | 200049805          |                    |                         |
| 06          |                    | 200049840          | 200049810          | 200049890          |                         |
| 07          | 200049970          | 200049845          | 200049815          |                    |                         |
| 08          |                    | 200049850          | 200049820          | 200049891          |                         |
| 09          |                    |                    | 65161*             |                    |                         |
| 10          |                    |                    |                    | 200049892          | 200049896               |
| 12          |                    |                    | 65162**            | 200049893          | 200049897               |
| 15          |                    |                    |                    | 200049864          | 200049898               |
| 18          |                    |                    |                    |                    | 200049899               |
| 20          |                    |                    |                    | 200049895          |                         |
| Weight      | 24g                | 44g                | 38g                | 54g                | 72g                     |

\* No traction, side jet from body.

\*\* With side & front jet

Male Threaded Drain Nozzles



| Nozzle Size   | 1/4" M Stainless Steel | 3/8" M Stainless Steel | 1/2" M Stainless Steel | 1/2" M Stainless Steel |
|---------------|------------------------|------------------------|------------------------|------------------------|
| Configuration | 1 x Forward, 3 x Rear  | 1 x Forward, 8 x Rear  | 0 x Forward, 3 x Rear  | 1 x Forward, 4 x Rear  |
| Rating        | 350bar, 90°C           |                        |                        |                        |
| 04            | 121160360              |                        |                        |                        |
| 06            |                        | 123160860              |                        |                        |
| 08            |                        |                        | 120000312              |                        |
| 09            |                        |                        |                        | 120110410              |

Silt Removal Drain Nozzles



Designed to de-silt & flush the bottom of pipes. Requires 2 x 1/4" M nozzles mounted at 45°. Max 420bar, 90°C



This heavy (1.5kg) forged brass nozzle is designed to sit on the bottom and de-silt the pipe. Requires 2 x ST357 turbo nozzles which give the unit considerable thrust. Max 350bar, 90°C



Maximum thrust nozzle designed to remove obstructions. Wedge shaped design for excellent debris penetration. Max 400bar, 90°C

| Part No   | Inlet  | Rear       | Weight | Part No   | Inlet  | Rear       | Weight | Part No   | Inlet  | Rear       | Weight |
|-----------|--------|------------|--------|-----------|--------|------------|--------|-----------|--------|------------|--------|
| 010000399 | 1/2" F | 2 x 1/4" F | 690g   | 200049410 | 3/8" F | 2 x 1/4" M | 1500g  | 200049405 | 1/4" F | 1 x 1/4" M | 198g   |

Drain Cleaning Heads for use with Suttner Turbo Nozzles



| Overall Nozzle Size Required | Driver Size Supplied | Turbo Nozzle Size Required Not supplied | 1/4" F        | 3/8" F        | 3/8" F        | 1/2" F        |
|------------------------------|----------------------|---|---------------|---------------|---------------|---------------|
|                              |                      |   | 6 x Rear Jets | 6 x Rear Jets | 6 x Rear Jets | 6 x Rear Jets |
|                              |                      |   | To Fit ST357  | To Fit ST357  | To Fit ST458  | To Fit ST458  |
| 065                          | 035                  | 03                                      | 993001        | 993031        | 993101        | 993131        |
| 075                          | 045                  | 03                                      | 993002        | 993032        | 993102        | 993132        |
| 085                          | 05                   | 035                                     | 993003        | 993033        | 993103        | 993133        |
| 095                          | 06                   | 035                                     | 993004        | 993034        | 993104        | 993134        |
| 10                           | 07                   | 03                                      | 993005        | 993035        | 993105        | 993135        |
| 12.5                         | 07                   | 055                                     | 993008        | 993038        | 993108        | 993138        |
| 15                           | 085                  | 055                                     | 993010        | 993040        | 993110        | 993140        |
| 20                           | 12                   | 08                                      | 993011        | 993041        | 993111        | 993141        |
| 30                           | 21                   | 09                                      | 993014        | 993044        | 993114        | 993144        |

Cylinder Style Drain Cleaning Nozzles 30° Angle



| Nozzle Size | 1/4" F                       | 3/8" F                       | 3/8" F                       | 1/2" F                       | 3/4" F                       | 1/2" M                       |
|-------------|------------------------------|------------------------------|------------------------------|------------------------------|------------------------------|------------------------------|
| 500 Bar     | 1 x Forward<br>6 x Rear Jets | 1 x Forward<br>4 x Rear Jets | 1 x Forward<br>6 x Rear Jets | 1 x Forward<br>6 x Rear Jets | 1 x Forward<br>6 x Rear Jets | 1 x Forward<br>6 x Rear Jets |
| 06          | 991266                       | 991235                       | 991306                       | 991336                       |                              | 991366                       |
| 08          | 991270                       | 991238                       | 991310                       | 991340                       |                              | 991370                       |
| 10          | 991272                       | 991240                       | 991312                       | 991342                       | 991391                       | 991372                       |
| 12          | 991274                       | 991242                       | 991314                       | 991344                       | 991392                       | 991374                       |
| 15          | 991277                       | 991245                       | 991317                       | 991347                       | 991393                       | 991377                       |
| 17          |                              |                              |                              |                              | 991394                       |                              |
| 20          | 991279                       | 991247                       | 991319                       | 991349                       | 991395                       | 991379                       |
| 25          |                              |                              |                              |                              | 991396                       | 991381                       |
| Weight      | 112g                         | 160g                         | 160g                         | 180g                         | 680g                         | 180g                         |

Milling Style Drain Cleaning Nozzles

Three or four very concentrated forward jets along with the sharp cutting edges, allow these Milling nozzles to tear through almost any kind of blockage, especially tree & plant roots.

The four or six rear facing jets give the nozzle it's thrust, allowing the nozzle to find it's way up the pipe.



| Nozzle | 1/4" F                        | 1/4" F                | 3/8" F                | 1/2" F                | 3/4" F                |
|--------|-------------------------------|-----------------------|-----------------------|-----------------------|-----------------------|
| Jets   | 3 x Drilled Forward, 4 x Rear | 4 x Forward, 4 x Rear | 4 x Forward, 6 x Rear | 4 x Forward, 6 x Rear | 4 x Forward, 6 x Rear |
| Rating | 350bar, 90°C                  | 350bar, 90°C          | 350bar, 90°C          | 350bar, 90°C          | 300bar, 90°C          |
| 045    | 992001                        |                       |                       |                       |                       |
| 05     | 992002                        |                       |                       |                       |                       |
| 055    | 992003                        |                       |                       |                       |                       |
| 06     |                               | 992501                |                       |                       |                       |
| 07     |                               | 992503                | 992532                | 992562                |                       |
| 08     |                               | 992505                | 992534                | 992564                |                       |
| 085    |                               | 992506                | 992535                | 992565                |                       |
| 10     |                               | 992508                | 992537                | 992567                |                       |
| 12.5   |                               | 992510                | 992538                | 992568                | 992591                |
| 15     |                               | 992513                | 992541                | 992571                | 992592                |
| 17.5   |                               |                       | 992542                | 992572                | 992593 (18)           |
| 20     |                               | 992515                | 992543                | 992573                | 992594                |
| 25     |                               |                       | 992545                | 992575                | 992595                |
| 30     |                               |                       | 992547                | 992577                | 992597                |
| 40     |                               |                       | 992548                | 992578                |                       |
| 46     |                               |                       | 992549                | 992579                | 992598                |
| Weight | 78g                           | 78g                   | 110g                  | 160g                  | 220g                  |



M5 hardened stainless steel spike extension for cylinder & milling nozzles  
040075090





Hydro Excavation Nozzles

For use where mechanical digging isn't feasible or practical. Ideal for delicate areas around cables and pipes.



| Nozzle Size | Part No                            |
|-------------|------------------------------------|
|             | 500bar, 100°C,<br>1/2" F, Ø = 31mm |
| 045         | 995003                             |
| 05          | 995004                             |
| 065         | 995005                             |
| 12          | 995006                             |
| 18          | 995007                             |
| 35          | 995008                             |

| Hydro Excavation Nozzle Protective Cone |
|---|
| 020002310                               |

Drain Nozzle Components



| Thread | Cylinder Style Nozzle Body Only - Female Thread | Cylinder Style Nozzle Body Only 1/2" M | Milling Style Body Only | Turbo Nozzle Drive Body Only | Hydro Excavation Body Only |
|--------|---|--|-------------------------|------------------------------|----------------------------|
| 1/4" F | 120000835                                       |  | 120000914               | 040075200                    |                            |
| 3/8" F | 120000850 (4xR)                                 |  | 120000938               | 040075205 - ST357            |                            |
| 3/8" F | 120000855                                       |  |                         | 040075210 - ST458            |                            |
| 1/2" F | 120000856                                       |  | 120000912               | 040075215                    | 120000830                  |
| 1/2" M |   | 120000857                              |                         |                              |                            |
| 3/4" F | 120000861                                       |  | 120000934               |                              |                            |
| 1" F   | 120000863                                       |  |                         |                              |                            |



| Ø     | M5 Nozzle Insert |
|-------|------------------|
| Blank | 040075000        |
| 0.5mm | 040075005        |
| 0.6mm | 040075006        |
| 0.7mm | 040075007        |
| 0.8mm | 040075008        |
| 0.9mm | 040075009        |
| 1.0mm | 040075010        |
| 1.2mm | 040075012        |
| 1.5mm | 040075015        |
| 2.0mm | 040075020        |

Sewer/Drain Cleaning Nozzles

All of our sewer & drain cleaning hoses come with a safety clearance marking 50cm from the end of the hose, to which the nozzle should be fitted.

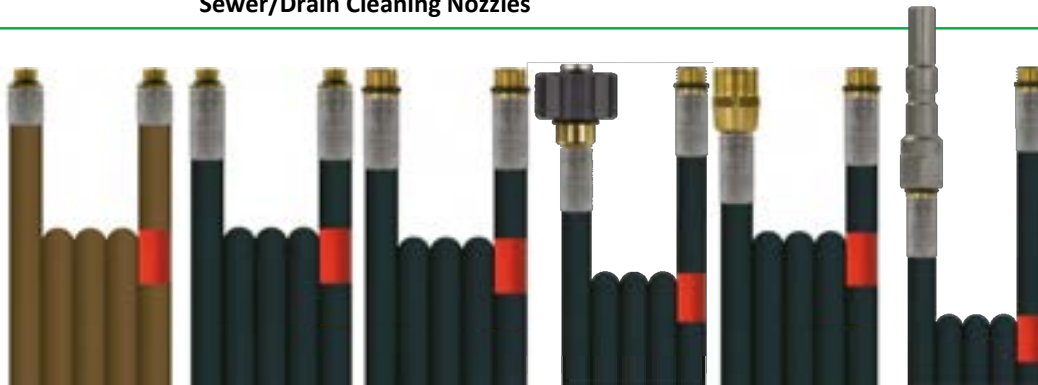

| Hose Type                 | DN | Mtr | 1/8" M    | 1/8" M    | 1/4" M    | M22F x 1/4" M | M22M x 1/4" M | KW x 1/4" M |
|---------------------------|----|-----|-----------|-----------|-----------|---------------|---------------|-------------|
| RM1, 300bar, 99°C         | 4  | 10  | 411040010 |           |           |               |               |             |
|                           | 4  | 20  | 411040020 |           |           |               |               |             |
| Flexy<br>300 bar<br>100°C | 6  | 10m |           | 420340010 | 420342010 | 420301010     | 420311010     | 420336010   |
|                           | 6  | 15m |           | 420340015 | 420342015 | 420301015     | 420311015     | 420336015   |
|                           | 6  | 20m |           | 420340020 | 420342020 | 420301020     | 420311020     | 420336020   |
|                           | 6  | 30m |           |           | 420342030 |               | 420311030     | 420336030   |
|                           | 6  | 40m |           |           | 420342040 |               |               |             |
|                           | 6  | 50m |           |           | 420342050 |               |               |             |

Sewerclean 365+



Sewerclean 365+ is a cut and abrasion resistant hose giving it a long operating life. Highly tear proof by two fold aramid fibre braids and polyurethane surface. The smooth cover, lightweight hose allows it to have a low friction resistance.

| Hose Type                       | DN | Mtr  | 1/2" F x 1/2" M |
|---------------------------------|----|------|-----------------|
| Sewerclean 365+<br>275bar, 60°C | 12 | 40m  | 457120040       |
|                                 | 12 | 60m  | 457120060       |
|                                 | 12 | 80m  | 457120080       |
|                                 | 12 | 100m | 457120100       |
|                                 | 12 | 120m | 457120120       |



Sewerstar 365+

Sewerstar365+ is a smooth covered, abrasion resistant hose. It is highly flexible due to it's specially formulated rubber compound. It also is lightweight with a low bend radius.



| Hose Type                          | DN | Mtr | 3/8" F x 1/4" M | 3/8" F x 3/8" M | 1/2" F x 1/2" M |
|------------------------------------|----|-----|-----------------|-----------------|-----------------|
| Sewerstar 365+<br>500bar, 150°C    | 8  | 40  | 556080040       |                 |                 |
|                                    | 8  | 80  | 556080080       |                 |                 |
| Sewerstar 365+<br>280bar,<br>150°C | 10 | 40  |                 | 558100040       |                 |
|                                    | 10 | 80  |                 | 558100080       |                 |
|                                    | 10 | 120 |                 | 558100120       |                 |
| Sewerstar 365+<br>250bar,<br>150°C | 12 | 40  |                 |                 | 557120040       |
|                                    | 12 | 80  |                 |                 | 557120080       |
|                                    | 12 | 100 |                 |                 | 557120100       |

**Micro Cleaning Hose & Nozzle Assemblies**



These micro cleaning nozzles have been designed to work in pipes with internal diameters of 10-12mm, such as those in heat exchangers and within the food industry. Due to the 2mm internal diameter, they require a minimum of 350bar to operate, with a maximum of 500bar. Rated to 60°C

| Length | DN | Nozzle Size (3R x 1F) | 350 - 500bar, 60°C |
|--------|----|-----------------------|--------------------|
| 2.0m   | 2  | 03                    | 4953340020         |
| 5.0m   | 2  | 03                    | 4953340050         |
| 8.0m   | 2  | 03                    | 495334080          |
| 10m    | 2  | 03                    | 4953340100         |
| 15.5m  | 2  | 03                    | 4953340155         |

**ST540 Foot Operated Valves**

Suttner ST540 foot valve allows for the insertion of either an ST2300, ST2600 or ST2700 series of wash gun.



|         | ST540 Body Only | ST540 Foot Valve with ST2605 Gun | ST540 Foot Valve with ST2750 Gun |
|---------|-----------------|----------------------------------|----------------------------------|
| Rating  |                 | 350bar, 45lpm, 150°C             | 500bar, 45lpm, 150°C             |
| Inlet   |                 | 3/8" F                           | 3/8" F                           |
| Outlet  |                 | 1/4" M                           | 1/4" M                           |
| Part No | 200540350       | 200540500                        | 200540550                        |

**ST550 Foot Operated Valves**



|         | ST550 Stainless Steel Foot Valve 1/4" F | ST550 Stainless Steel Foot Valve M22 |
|---------|---|--------------------------------------|
| Rating  | 500bar, 80lpm, 150°C                    | 500bar, 80lpm, 150°C                 |
| Inlet   | 1/4" F                                  | M22M                                 |
| Outlet  | 1/4" F                                  | M22F                                 |
| Part No | 200550600                               | 200550620                            |





## GUNS AND LANCES

|   |           |
|---|-----------|
| <b>Suttner Gun Range</b>                    | <b>78</b> |
| <b>20 - 80bar Suttner Guns</b>              | <b>79</b> |
| <b>125 - 310bar Suttner Guns</b>            | <b>80</b> |
| <b>310 - 600bar Suttner Guns</b>            | <b>81</b> |
| <b>TecPro Gun &amp; Lance Sets</b>          | <b>82</b> |
| <b>HACCP Guns &amp; Lances</b>              | <b>83</b> |
| <b>Lance Pipes &amp; Moulded Lances</b>     | <b>84</b> |
| <b>Lance Assemblies</b>                     | <b>85</b> |
| <b>Easyturn &amp; ST85 Push-Pull Lances</b> | <b>86</b> |
| <b>Telescopic &amp; Longcast Lances</b>     | <b>87</b> |
| <b>Twin Lances</b>                          | <b>88</b> |
| <b>Lance Quick Release Connections</b>      | <b>89</b> |
| <b>Foot Valves &amp; Lance Holders</b>      | <b>90</b> |

Suttner High Pressure Wash Guns Range























Made of plastics intended to come into contact with foodstuffs according to EC No. 1935/2004



**Low Trigger Force**  
40% easier to pull and 90% easier to hold than a standard wash gun



**Low Trigger Force Plus**  
55% easier to pull and 90% easier to hold than a standard wash gun

|   | Model             | Max Pressure | Max Flow | Max Temp °C | USP   |
|---|-------------------|--------------|----------|-------------|---|
|   | ST860D            | 20           | 30       | 200         | Light Duty Steam Gun  |
|   | ST4000            | 24           | 50       | 200         | Professional Steam Gun  |
|       | ST3225            | 24           | 120      | 100         | Inline Stainless Steel Gun  |
|    | ST3100            | 60           | 100      | 150         | Foam Gun with Dampened Trigger Mechanism  |
|    | ST3225            | 60           | 120      | 100         | Inline Stainless Steel Gun  |
|       | ST2720            | 80           | 80       | 150         | Red Medium Pressure, High Flow Stainless Gun  |
|       | ST2725            | 80           | 80       | 150         | Stainless Steel with Progressive Closing Trigger  |
|       | ST2720            | 125          | 80       | 150         | Blue High Pressure, High Flow Stainless Gun   |
|   | ST2320            | 150          | 80       | 150         | High Pressure, High Flow Rate Gun   |
|   | ST810             | 210          | 30       | 150         | Front Entry Gun   |
|   | ST1100            | 210          | 30       | 150         | Economy Standard Gun  |
|    | ST2620 - EasyFarm | 250          | 60       | 150         | Green Casing Gun for Agriculture  |
|   | ST601             | 275          | 45       | 150         | Inline Wash Gun   |
|   | ST1500            | 275          | 45       | 150         | Classic Suttner High Pressure Gun   |
|   | ST2000            | 275          | 45       | 150         | High Pressure Gun with Robust Plastic Casing  |
|   | ST2300            | 310          | 45       | 150         | Most Popular Gun Model, Lots of Versions  |
|    | ST2600            | 310          | 45       | 150         | As Above but with 'Easy Pull' Trigger   |
|    | ST2600 - EasyWash | 310          | 45       | 150         | Blue & Orange Casing for Car Wash Industry  |
|   | ST2700            | 310          | 45       | 150         | Stainless Steel Gun with 'Easy Pull' Trigger  |
|   | ST2315            | 350          | 45       | 150         | Ceramic Ball for Increased Chemical Resistance  |
|    | ST2605            | 350          | 45       | 150         | Higher Pressure Rating Gun with 'Easy Pull Trigger'   |
|    | ST2615            | 350          | 45       | 150         | 'Easy Pull' Trigger Gun with Ceramic Ball   |
|   | ST2715            | 350          | 45       | 150         | Stainless Steel Gun with Ceramic Ball   |
|   | ST3500            | 350          | 200      | 150         | 200lpm Flow Rate High Pressure Gun  |
|    | ST2635            | 400          | 35       | 150         | 'Industrial' Series Gun for Higher Pressure. Premium version comes with Ball Bearing ST303 Swivel |
|    | ST2750            | 500          | 30       | 150         | 500Bar Gun with Standard Sized Body   |
|   | ST3600            | 600          | 80       | 150         | Suttner Premium UHP Gun   |

Symbols Key



Made of plastics intended to come into contact with foodstuffs according to EC No. 1935/2004



**Low Trigger Force**  
40% easier to pull and 90% easier to hold than a standard wash gun



**Low Trigger Force Plus**  
55% easier to pull and 90% easier to hold than a standard wash gun

Suttner Wash Guns 20 - 80 bar



| Inlet         | Outlet    | ST860 Steam Gun     | ST860 + 220mm Extension | ST4000 Pro Steam Gun + 500mm Lance | ST3100 Gun + Compensated Trigger | ST2725 Hi Flow, Med Pressure |
|---------------|-----------|---------------------|-------------------------|------------------------------------|----------------------------------|------------------------------|
| Rating        |           | 20bar, 30lpm, 200°C | 20bar, 30lpm, 200°C     | 24bar, 50lpm                       | 60bar, 100lpm                    | 80bar, 80lpm                 |
| 1/4" F        | 1/4" F    | 200860550           |                         |                                    |                                  |                              |
| 1/4" F        | 1/4" F    |                     | 200860555               |                                    |                                  |                              |
| 1/2" F Swivel | 1/2" F    |                     |                         |                                    |                                  | 202725535                    |
| 1/2" F        | ST3100QRC |                     |                         |                                    | 203100820                        |                              |
| 1/2" F Swivel | ST3100QRC |                     |                         |                                    | 203100805                        | 202725550                    |
| 3/4" F        | 40200     |                     |                         | 204000500                          |                                  |                              |

ST3225 Stainless Steel Inline, High Flow Wash Gun



ST3225 - The professional gun for the food industry

- Available in 24 & 60bar versions
- Especially designed to the highest requirements for hygiene and ergonomics.
- Extremely light at only 745g
- Stainless steel construction
- Made out of plastics intended to come into contact with foodstuffs according to Regulation (EC) No.1935/2004
- Suitable for high flows of up to 120lpm
- Progressive trigger closing system by means of an integrated damper
- 24bar version has the ability to lock the trigger in the open position.
- Very low pressure drop (3.6bar @ 85lpm)
- Opening and holding force at 60 bar and 28lpm is only 21.10n



| Inlet         | Outlet     | ST3225 24 Bar Version <span>SS</span> | ST3225 60 Bar Version <span>SS</span> |
|---------------|------------|---------------------------------------|---------------------------------------|
| Rating        |            | 120lpm, 100°C                         | 120lpm, 100°C                         |
| 1/2" F Swivel | 1/2" F     | 203225645                             | 203225545                             |
| 1/2" F Swivel | ST3100 QRC | 203225650                             | 203225550                             |

## GUNS & LANCES

### Suttner High Pressure Wash Guns, 125 - 210 bar

**LTF**

Low Trigger Force  
40% Easier to pull  
90% Easier to hold  
than a standard wash gun



| Inlet         | Outlet           | ST2720 - Red  | ST2720 - Blue | ST2320<br>Kommunal 365+ | ST810<br>Front Entry | ST1100        |
|---------------|------------------|---------------|---------------|-------------------------|----------------------|---------------|
|               |                  | 125bar, 80lpm | 125bar, 80lpm | 150bar, 80lpm           | 210bar, 30lpm        | 210bar, 30lpm |
| 3/8" F        | 1/4" F           | 202720500     |               |                         |                      | ST1100        |
| 1/2" F        | 3/8" F           |               | 202720530     |                         |                      |               |
| 1/2" F Swivel | ST3100QRC        |               | 202720550     | 202320566 (blue)        |                      |               |
| 1/2" F        | 1/4" F           |               |               | 202320500               |                      |               |
| 1/2" F        | 1/2" F           |               |               | 202320510               |                      |               |
| 1/2" F Swivel | 1/2" F           |               |               | 202320520               |                      |               |
| 1/4" F        | 1/4" F           |               |               |                         | 200810530            |               |
| 3/8" F Swivel | 1/4" F           |               |               |                         |                      | 201100540     |
|               | Valve Repair Kit | 202710490     | 202710490     | 202320495               |                      |               |

### Suttner High Pressure Wash Guns, 250 - 310 bar

**LTF**

Low Trigger Force  
40% Easier to pull  
90% Easier to hold  
than a standard wash gun



| Inlet         | Outlet                   | ST2620 EASYFARM      | ST601<br>Inline Gun  | ST1500               | ST2000               | ST2300               |
|---------------|--------------------------|----------------------|----------------------|----------------------|----------------------|----------------------|
| Rating        |                          | 250bar, 60lpm, 150°C | 275bar, 45lpm, 150°C | 275bar, 45lpm, 150°C | 275bar, 45lpm, 150°C | 310bar, 45lpm, 150°C |
| 3/8" F        | 1/4" F                   |                      | 200601600            | 201500500            | 202000500            | 202300500            |
| 3/8" F        | 1/4" F Freeze Stop       |                      |                      | 201500580            |                      |                      |
| 3/8" F        | 1/4" F Weep Valve        |                      |                      | 201500620            |                      |                      |
| 3/8" F        | 1/4" F + Pole Fixing Kit |                      | BX001                |                      |                      |                      |
| 3/8" F        | KW QRC                   |                      |                      | 201500660            |                      | 202300560            |
| 3/8" F Swivel | 1/4" F                   |                      |                      | 201500560            | 202000590            | 202300550            |
| 3/8" F Swivel | 1/4" F Freeze Stop       |                      |                      | 201500581            |                      |                      |
| 3/8" F Swivel | 1/4" F Weep Valve        |                      |                      |                      |                      | 202300581            |
| 3/8" F Swivel | KW QRC                   |                      |                      | 201500670            |                      | 202300570            |
| 1/2" Swivel   | ST3100 QRC               | 202620650            |                      |                      |                      |                      |
| 1/2" Swivel   | KW QRC                   | 202620655            |                      |                      |                      |                      |
| M22M          | 1/4" F                   |                      |                      |                      |                      | 202300520            |
| M22M Swivel   | 1/4" F                   |                      |                      |                      |                      | 202300553            |
| M22M Swivel   | KW QRC                   |                      |                      |                      |                      | 202300605            |
|               | Valve Repair Kit         |                      | 202000044            | 202000044            | 202000044            | 202300490            |



## GUNS & LANCES

### Suttner High Pressure Wash Guns 310 - 350bar

**LTF**

Low Trigger Force  
40% Easier to pull  
90% Easier to hold  
than a standard wash gun



| Inlet         | Outlet               | ST2600               | ST2600 EasyWash      | ST2600 Easywash + Ball Bearing Swivel | ST2700 Stainless Steel | ST3240 Inline Gun     |
|---------------|----------------------|----------------------|----------------------|---------------------------------------|------------------------|-----------------------|
|               |                      | 310bar, 45lpm, 150°C | 310bar, 45lpm, 150°C | 310bar, 45lpm, 150°C                  | 310bar, 45lpm, 150°C   | 310bar, 120lpm, 100°C |
| 3/8" F        | 1/4" F               | 202600500            |                      |                                       | 202700500              |                       |
| 3/8" F        | KW QRC               | 202600540            |                      |                                       | 202700560              |                       |
| 3/8" F Swivel | 1/4" F               | 202600550            | 202600518            | 202600514                             | GS2753                 |                       |
| 3/8" F Swivel | KW QRC               | 202600545            |                      |                                       | 202700575              |                       |
| 3/8" F Swivel | 1/4" F + Weep Valve  |                      | 202600528            | 202600524                             |                        |                       |
| 3/8" F Swivel | 1/4" F + Freeze Stop |                      | 202600538            | 202600534                             |                        |                       |
| 1/2" F        | 1/2" F               |                      |                      |                                       |                        | 203240500             |
|               | Valve Repair Kit Std | 202300490            | 202300490            |                                       | 202700490              |                       |

### Suttner High Pressure Wash Guns 350 bar

**LTF**

Low Trigger Force  
40% Easier to pull  
90% Easier to hold  
than a standard wash gun



| Inlet         | Outlet           | ST2315 + Ceramic Ball | ST2605               | ST2615 + Ceramic Ball | ST2615 + Ceramic Ball | ST2715               |
|---------------|------------------|-----------------------|----------------------|-----------------------|-----------------------|----------------------|
|               |                  | 350bar, 45lpm, 150°C  | 350bar, 45lpm, 150°C | 350bar, 45lpm, 150°C  | 350bar, 45lpm, 150°C  | 350bar, 45lpm, 150°C |
| 3/8" F        | 1/4" F           | 202315500             | 202605500            | 202615500             |                       | 202715500            |
| 3/8" F Swivel | 1/4" F           | 202315550             |                      | 202615550             |                       |                      |
| 3/8" F Swivel | KW QRC           |                       |                      |                       | 202615525             |                      |
|               | Valve Repair Kit | 202315490             |                      | 202315490             | 202315490             | 202700445            |

### Suttner High Pressure Wash Guns 400 - 600 bar

**LTF+**

Low Trigger Force  
55% Easier to pull  
90% Easier to hold  
than a standard wash gun



| Inlet         | Outlet | ST2635 Industrial    | ST2635 Premium Inc ST303 Swivel | ST2750               | ST3600 500 Bar       | ST3600 600 Bar       |
|---------------|--------|----------------------|---------------------------------|----------------------|----------------------|----------------------|
|               |        | 400bar, 45lpm, 150°C | 400bar, 45lpm, 150°C            | 500bar, 30lpm, 150°C | 500bar, 80lpm, 150°C | 600bar, 80lpm, 150°C |
| 3/8" F        | 1/4" F |                      |                                 | 202750500            |                      |                      |
| 3/8" F Swivel | 1/4" F | 202635550            | 202635555                       |                      |                      |                      |
| 3/8" F Swivel | KW QRC | 202635570            | 202635575                       |                      |                      |                      |
| 1/2" F        | 1/4" F |                      |                                 |                      |                      | 203600545            |
| 1/2" F        | 1/2" F |                      |                                 |                      |                      | 203600550            |
| M22M          | 1/4" F |                      |                                 |                      | 203600555            |                      |
| M22M Swivel   | M22M   | 202635720            |                                 |                      |                      |                      |

## GUNS & LANCES

### TecPro Branded High Pressure Gun & Lance Assemblies - Made by Suttner



| Inlet  | Outlet | TecPro Gun<br>Only available in boxes of 50 | TecPro Gun + 900mm Lance | TecPro Gun + 900mm Lance +<br>Nozzle Protector |
|--------|--------|---|--------------------------|--|
|        |        | 275bar, 30lpm                               | 275bar, 30lpm            | 275bar, 30lpm                                  |
| 3/8" F | 1/4" F | GS1573                                      |                          | 201100800                                      |
| 3/8" F | 1/4" M |   | 201500872                |  |

### TecPro Branded High Pressure Gun & Lance Assemblies inc Nozzle



| Inlet  | Outlet Nozzle Size | Gun + 900mm Lance + Nozzle Protector + Nozzle | Gun + 900mm Lance + ST357 Turbo Nozzle |
|--------|--------------------|---|--|
| 3/8" F | 035                | 201100835                                     | 201100635                              |
| 3/8" F | 04                 | 201100840                                     | 201100640                              |
| 3/8" F | 045                | 201100845                                     | 201100645                              |
| 3/8" F | 05                 | 201100850                                     | 201100650                              |
| 3/8" F | 055                | 201100855                                     | 201100655                              |
| 3/8" F | 06                 | 201100860                                     | 201100660                              |
| 3/8" F | 065                |   | 201100665                              |

### Suttner High Pressure Inline Gun Swivels



| Inlet  | Outlet     | ST301        | ST300        | ST300 Brass  | ST300<br>SS & N.P Brass | ST310        | ST340        | ST303         | ST350        |
|--------|------------|--------------|--------------|--------------|-------------------------|--------------|--------------|---------------|--------------|
|        | Rating     | 350bar, 90°C | 275bar, 90°C | 275bar, 90°C | 275bar, 90°C            | 350bar, 90°C | 350bar, 90°C | 400bar, 100°C | 500bar, 90°C |
| 1/4" F | 1/4" M     |              |              | 200300040    |                         |              |              |               |              |
| 3/8" F | 1/4" F     | 200301050    | 200300000    |              |                         |              |              | 200303050     |              |
| 3/8" F | 3/8" M     |              |              |              | 200300010               | 200310010    |              |               | 200350010    |
| 1/2" F | 1/2" M     |              |              |              |                         | 200310040    | 200340010    |               |              |
|        | Repair Kit | 200300100    | 200300100    |              | 200300100               | 200300100    | 200340100    |               | 200300100    |

HACCP Compliant Coloured Replacement Gun Bodies

Hazard Analysis and Critical Control Point (HACCP) is a way of managing food safety hazards. The HACCP management system allows for food safety to be addressed through analysis and control of biological, chemical and physical hazards, from raw material production, procurement and handling, to manufacturing distribution and consumption of the finished product. All products listed are made from 1935/2004/EC compliant materials as per EC regulation 10/2011/EC



| Red Cover Set                       | Yellow Cover Set                    | Green Cover Set                     | Blue Cover Set                      |
|-------------------------------------|-------------------------------------|-------------------------------------|-------------------------------------|
| Fits ST2300, 2600 & 2700 gun series | Fits ST2300, 2600 & 2700 gun series | Fits ST2300, 2600 & 2700 gun series | Fits ST2300, 2600 & 2700 gun series |
| 202300471                           | 202300472                           | 202300473                           | 202300474                           |

HACCP Compliant Coloured Stainless Steel Lances

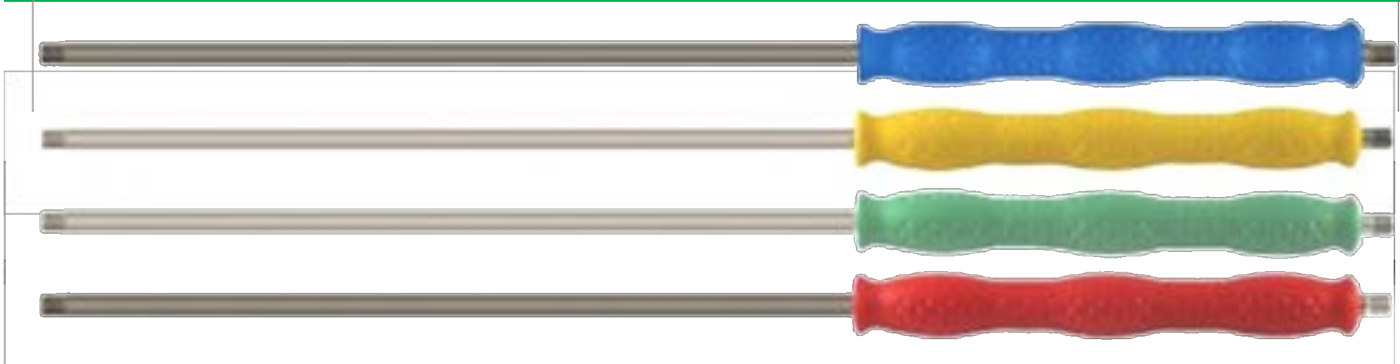

The Suttner ST29 stainless steel lances are ideal for areas requiring fast identification for segregation purposes. They can also be simply used to identify your companies colour or for use on hire fleets. The lance complies with Chapter 13 of HACCP. Ideal when used in conjunction with the gun bodies above.

| Blue ST29 Stainless 900/300 Lance | Yellow ST29 Stainless 900/300 Lance | Green ST29 Stainless 900/300 Lance | Red ST29 Stainless 900/300 Lance |
|-----------------------------------|-------------------------------------|------------------------------------|----------------------------------|
| Max 400bar, 150°C                 | Max 400bar, 150°C                   | Max 400bar, 150°C                  | Max 400bar, 150°C                |
| 200029315                         | 200029316                           | 200029317                          | 200029318                        |

HACCP Compliant Nozzle Protectors



| Red       | Green     | Yellow    | White     | Blue      | Grey      | Black     |
|-----------|-----------|-----------|-----------|-----------|-----------|-----------|
| 020001121 | 020001122 | 020001123 | 020001124 | 020001149 | 020001157 | 020001158 |

HACCP Compliant Lance Clips - made from food safe polypropylene

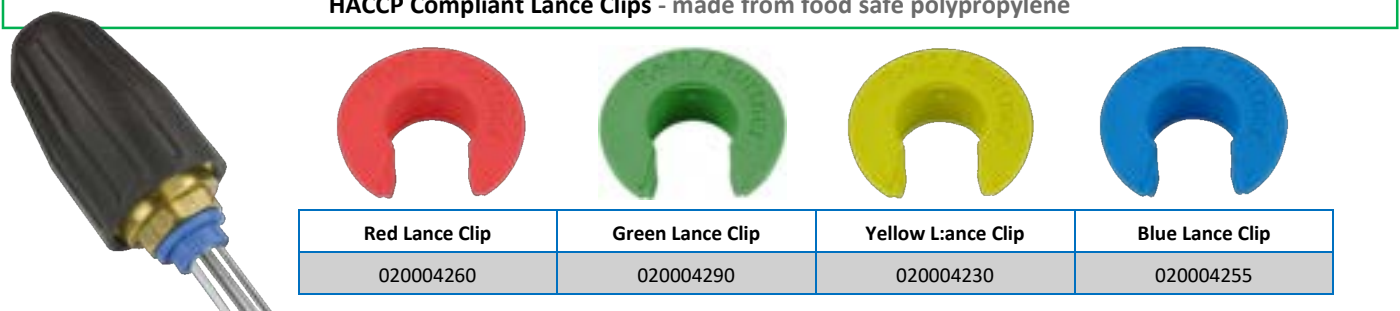

| Red Lance Clip | Green Lance Clip | Yellow Lance Clip | Blue Lance Clip |
|----------------|------------------|-------------------|-----------------|
| 020004260      | 020004290        | 020004230         | 020004255       |

## GUNS & LANCES

### ST001 Lance Pipes & ST007 Moulded Lances



Rating 400bar, 150°C

| Length (mm) | ST001 Zinc Plated Pipe | ST001 Stainless Steel Pipe | Insulation Length (mm) | ST007 Zinc Plated Moulded Lance | ST007 Stainless Steel Black Moulded Lance | ST007 Stainless Steel Blue Moulded Lance |
|-------------|------------------------|----------------------------|------------------------|---------------------------------|---|--|
| 48          |                        | 070000488                  |                        |                                 |   |  |
| 63          |                        | 070000638                  |                        |                                 |   |  |
| 100         |                        | 070001008                  |                        |                                 |   |  |
| 115         |                        | 070000270                  |                        |                                 |   |  |
| 120         |                        | 070001197                  |                        |                                 |   |  |
| 140         |                        | 070001397                  |                        |                                 |   |  |
| 150         |                        | 070001508                  |                        |                                 |   |  |
| 330         | 070103351              | 070003228                  | 330/300                | 070000330                       | 070003229                                 |  |
| 433         | 070000026              | 070004338                  | 433/400                | 070000240                       | 070009433                                 | 070004340                                |
| 500         | 070000030              | 070005008                  | 500/300                | 070000170                       | 070005009                                 | 070005010                                |
| 600         | 070000040              | 070006008                  | 600/300                | 070000180                       | 070006009                                 |  |
| 700         |                        |                            | 700/300                |                                 | 070007009                                 |  |
| 800         | 070000050              | 070008008                  | 800/400                | 070000190                       | 070008009                                 |  |
| 900         |                        |                            | 900/300                | 070000470                       |   |  |
| 900+NP      |                        |                            | 900/300                | GS900                           | ST900ss                                   |  |
| 1000        | 070000060              | 070010008                  | 1000/400               | 070000200                       | 070010009                                 | 070010010                                |
| 1200        | 070000070              | 070012008                  | 1200/500               | 070000210                       | 070012009                                 |  |
| 1500        | 070000080              | 070015008                  | 1500/500               | 070000220                       | 070015009                                 |  |
| 2000        | 070000090              | 070020008                  | 2000/500               | 070000230                       | 070020009                                 |  |

### ST28, ST29 & ST129 Ergo Grip Lances

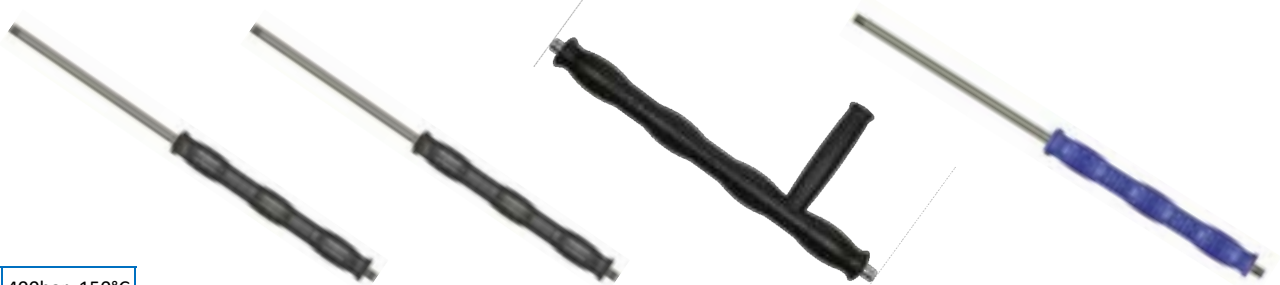

Rating 400bar, 150°C

| Length/Ins (mm) | Insulation Colour | ST28 Z.P Cool & Compact Lance | ST29 Stainless Steel Cool & Compact Lance | ST29 Stainless Steel Lance with Integrated Side Handle | Length/Ins (mm) | ST129 Stainless Blue Cool & Compact Lance |
|-----------------|-------------------|-------------------------------|---|--|-----------------|---|
| 330/300         | Black             | 200028303                     |   |  |                 |   |
| 433/400         | Black             |                               |   | 200029204  |                 |   |
| 500/300         | Black             | 200028305                     | 200029305                                 |  |                 |   |
| 600/300         | Black             | 200028306                     | 200029306                                 |  | 600/300         | 200129306                                 |
| 700/300         | Black             | 200028307                     | 200029307                                 |  | 740/700         |   |
| 800/400         | Black             | 200028408                     |   |  | 800/400         | 200129408                                 |
| 900/300         | Black             | 200028309                     | 200029309                                 |  | 900/700         | 200129709                                 |
| 1000/400        | Black             |                               | 200029410                                 | 200029210  |                 |   |
| 1200/300        | Black             | 200028312                     | 200029312                                 |  |                 |   |
| 1200/700        | Black             |                               | 200029712                                 |  | 1200/700        | 200129712                                 |

## GUNS & LANCES

### Moulded Grip Lances



|          | Zinc Plated ST007 Moulded Lance<br>+ ST10 Nozzle Protector |               | Stainless Steel ST007 Moulded Lance<br>+ ST10 Nozzle Protector |               | U Form Stainless Steel Lance |
|----------|--|---------------|--|---------------|------------------------------|
|          | Straight   | + 15° Bend    | Straight   | + 15° Bend    | 15° Bend                     |
| Rating   | 400bar, 150°C  | 400bar, 150°C | 400bar, 150°C  | 400bar, 150°C | 250bar, 150°C                |
| 500/300  | 512103   |               | 512193   |               |                              |
| 600/300  | 512203   |               | 512293   |               |                              |
| 800/400  | 512303   | 5123031       | 512393   | 5123931       |                              |
| 900/300  | GS900  |               | ST900ss  |               | 070009011                    |
| 1000/400 | 512403   | 5124031       | 512493   | 5124931       |                              |
| 1200/500 | 512503   | 5125031       | 512593   | 5125931       |                              |
| 1500/500 | 512603   | 5126031       | 512693   | 5126931       |                              |
| 2000/500 | 512803   | 5128031       | 512893   | 5128931       |                              |

### Vented Grip Lances



|          | Zinc Plated Pipe + Vented Insulation |                           | Stainless Steel Pipe + Vented Insulation |                           |
|----------|--------------------------------------|---------------------------|--|---------------------------|
|          | Basic 1/4" M end                     | Inc ST10 Nozzle Protector | Basic 1/4" M end                         | Inc ST10 Nozzle Protector |
| Rating   | 400bar, 150°C                        | 400bar, 150°C             | 400bar, 150°C                            | 400bar, 150°C             |
| 500/380  | 51120                                | 511201                    | 51129                                    | 5112019                   |
| 600/380  | 51130                                | 511301                    | 51139                                    | 5113019                   |
| 800/380  | 51140                                | 511401                    | 51149                                    | 5114019                   |
| 1000/380 | 51150                                | 511501                    | 51159                                    | 5115019                   |
| 1200/380 | 51160                                | 511601                    | 51169                                    | 5116019                   |
| 1500/380 | 51170                                |                           | 51179                                    |                           |
| 1500/760 | 51171                                | 511701                    | 511719                                   | 5117019                   |
| 2000/760 | 51190                                | 511901                    | 51199                                    | 5119019                   |

### Lance Extensions



| Length | Lance Pipe | Inlet  | Lance Extension with KW QRC | Lance Extension with M22F | Ergo Lance extension with M22F | Vented Insulation Only |
|--------|------------|--------|-----------------------------|---------------------------|--------------------------------|------------------------|
| 260mm  | SS         | 1/4" M | 200009750                   |                           |                                |                        |
| 340mm  | Z.P        | 1/4" M |                             | 202300400                 |                                |                        |
| 350mm  | Z.P        | 1/4" M |                             |                           | 200009731                      |                        |
| 380mm  | -          |        |                             |                           |                                | 200009510              |

## GUNS & LANCES

### ST9.4 & ST9.7 Easyturn Lances

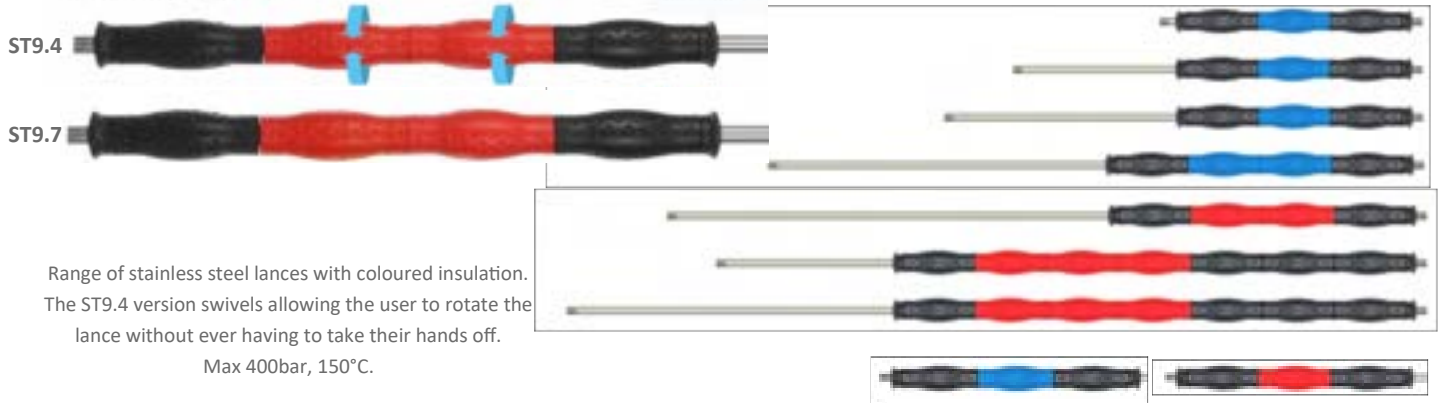

| Length | Insulation Length | ST9.4 with Swivel Grip | ST9.4 with Swivel Grip | ST9.7 with Fixed Grip | ST9.7 with Fixed Grip |
|--------|-------------------|------------------------|------------------------|-----------------------|-----------------------|
| 330mm  | 300mm             |                        |                        | 510033100100          | 510033102000          |
| 370mm  | 330mm             | 510033000100           | 510033002000           |                       |                       |
| 500mm  | 330mm             | 510053000100           | 510053002000           | 510053100100          |                       |
| 600mm  | 330mm             | 510063000100           | 510063002000           | 510063100100          | 510063102000          |
| 700mm  | 430mm             | 510074000200           | 510074002100           | 510074100200          | 510074102100          |
| 900mm  | 730mm             |                        |                        | 510097100500          |                       |
| 1000mm | 430mm             | 510104000200           | 510104002100           |                       |                       |
| 1200mm | 730mm             |                        | 510127002400           | 510127100500          | 510127102400          |

### ST85 Push & Pull Lances



| Length (mm) | ST85 Z.P Push & Pull 1/4" F | ST85 SS Push & Pull 1/4" F | ST85 Z.P Push & Pull QR Spigot | ST85 SS Push & Pull QR Spigot | ST85 Z.P Push & Pull M22M | ST85 SS Push & Pull M22M |
|-------------|-----------------------------|----------------------------|--------------------------------|-------------------------------|---------------------------|--------------------------|
| Rating      | 210bar, 150°C               | 210bar, 150°C              | 210bar, 150°C                  | 210bar, 150°C                 | 210bar, 150°C             | 210bar, 150°C            |
| 600         | 200085200                   | 200085250                  | 200085210                      | 200085260                     | 200085220                 | 200085270                |
| 850         | 200085710                   | 200085810                  | 200085510                      | 200085610                     |                           |                          |
| 1000        | 200085700                   | 200085800                  | 200085500                      | 200085600                     |                           |                          |
| 1500        | 200085750                   | 200085850                  | 200085550                      | 200085650                     |                           |                          |
| Spare Hose  | 200085300                   | 200085300                  | 200085300                      | 200085300                     | 200085300                 | 200085300                |
| Wheel Set   | 200085400                   | 200085400                  | 200085400                      | 200085400                     | 200085400                 | 200085400                |

Suttner High Pressure Telescopic Lances with ST602 Inline Gun



| Length     | Pole Construction | 1/4" M Straight | Tip Nozzle Holder + 15° Bend | 1/4" F Nozzle Protector + 15° Bend |
|------------|-------------------|-----------------|------------------------------|------------------------------------|
| Inlet      |                   | 3/8" F          | M22M                         | 3/8" F                             |
| 2.5 - 3.8m | Carbon Fibre/Alu  | 525087115       | 525087105                    | 525087110                          |
| 2.5 - 5.7m | Carbon Fibre/Alu  | 525087215       | 525087205                    | 525087210                          |
| 3.2 - 7.8m | Carbon Fibre/Alu  | 525087315       | 525087305                    | 525087310                          |
| 3.2 - 7.5m | Aluminium         | 525087415       | 525087405                    | 525087410                          |

Telescopic Lance Accessories



| Length     | Replacement Internal Hose |
|------------|---------------------------|
|            | 1/4" F x 1/4" F 90°       |
| 2.3 - 3.8m | 5250708H                  |
| 2.3 - 5.6m | 5250858H                  |
| 2.9 - 7.4m | 5251008H                  |

| 500mm Gutter Cleaning Attachment | Belt Kit                  |
|----------------------------------|---------------------------|
| M22M x Mini QRC Coupling         | Suitable for above lances |
| GUT135                           | 525920                    |

Longcast Lances & Nozzles

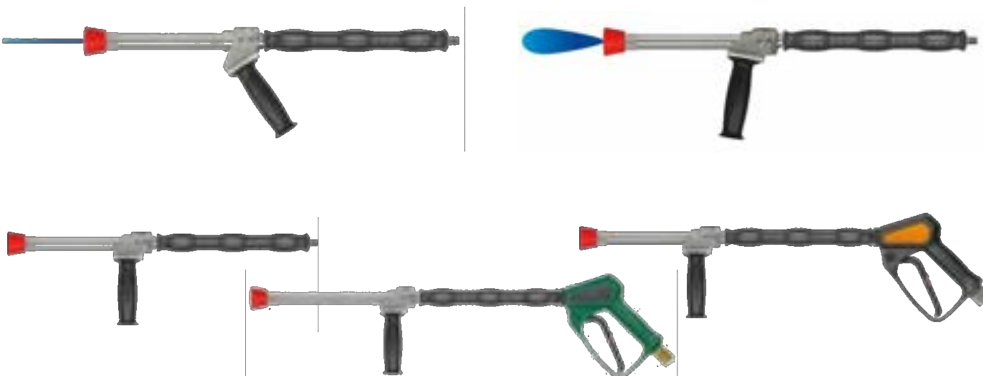

| Longcast Lance only 1/4" M<br>Without nozzle | Longcast Lance + ST2320 Gun<br>1/2" F Inlet. Without Nozzle | Longcast Lance + 2620 Gun<br>1/2" F Inlet. Without Nozzle |
|--|---|---|
| 280 bar, 130lpm, 100°C                       | 150 bar, 80lpm, 100°C                                       | 250 bar, 60lpm, 100°C                                     |
| 200078500                                    | 200078520   | 200078530   |

| Longcast Nozzle<br>Ø mm | Part No   |
|-------------------------|-----------|
| 1.2                     | 200078412 |
| 1.5                     | 200078415 |
| 1.8                     | 200078418 |
| 2.0                     | 200078420 |
| 2.3                     | 200078423 |
| 2.5                     | 200078425 |
| 3.0                     | 200078430 |
| 3.5                     | 200078435 |

**ST53 Twin Lances (Top Adjust)**

All ST53 & ST54 lances come with a low pressure nozzle, high pressure nozzles are sold separately.



| Length (mm)     |           | ST53 Valve, L.P Nozzle & QR Spigot | Super short ST53 Top Adjust 1/4" F | ST53 Top Adjust Z.P Pipe | ST53 Top Adjust Stainless Pipe |
|-----------------|-----------|------------------------------------|------------------------------------|--------------------------|--------------------------------|
| Rating          | Inlet     | 250 bar, 150°C                     | 250 bar, 150°C                     | 250 bar, 150°C           | 250 bar, 150°C                 |
| 100             | KW Spigot | 51605                              |                                    |                          |                                |
| 210             | 1/4" F    |                                    | 200053710                          |                          |                                |
| 600             | 1/4" F    |                                    |                                    | 51610                    | 200053610                      |
| 1000            | 1/4" M    |                                    |                                    | 51660                    | 200053600                      |
| Spare Valve     |           | 120000010                          | 120000010                          | 120000010                | 120000010                      |
| Knob Repair Kit |           | 120000005                          | 120000005                          | 120000005                | 120000005                      |

**ST54 Twin Lances (Side Adjust)**



| Length (mm)    |        | ST54 Vertical Twin Lance Z.P Pipe | ST54 Vertical Twin Lance Stainless Pipe | ST54 Horizontal Twin Lance Z.P Pipe | ST54 Horizontal Twin Lance Stainless Pipe |
|----------------|--------|-----------------------------------|---|-------------------------------------|---|
| Rating         | Inlet  | 310bar, 150°C                     | 310 bar, 150°C                          | 310 bar, 150°C                      | 310 bar, 150°C                            |
| 600            | 1/4" F | 51750                             | 200054605                               | 200054850                           | 200054950                                 |
| 1000           | 1/4" M | 51760                             | 200054600                               | 200054800                           | 200054900                                 |
| Valve + Handle |        | 200054492                         | 200054492                               | 200054480                           | 200054480                                 |
| Spare Handle   |        | 200054450                         | 200054450                               | 200054450                           | 200054450                                 |



| Length (mm)    |        | ST54.2 Stainless Steel Twin Lance with Soft Grip Side Handle | ST154 500 bar Rated Stainless Steel Twin Lance |
|----------------|--------|--|--|
| Rating         | Inlet  | 400bar, 150°C  | 500 bar, 150°C                                 |
| 650            | 1/4" F | 517054605  | 200154510                                      |
| 980            | 1/4" M | 517054600  | 200154500                                      |
| Valve + Handle |        | 517054492  | 200154490                                      |
| Spare Handle   |        | 517054450  | 200154400                                      |

**Twin Lance Spare Parts**



| ST53 Valve | ST53 Knob Repair Kit | ST54 Vertical Valve | ST54 Horizontal Valve | ST54 Repair Kit | ST54.2 Repair Kit |
|------------|----------------------|---------------------|-----------------------|-----------------|-------------------|
| 120000010  | 120000005            | 200054492           | 200054480             | 200054450       | 517054450         |



Gun Couplings & Spigots



|         | QRC for Spigot with 1/4" M |                      |                     | QRC for Spigot to fit Original Suttner QRC Guns |                |                  |                   |                       |
|---------|----------------------------|----------------------|---------------------|---|----------------|------------------|-------------------|-----------------------|
| Desc    | Black Body Brass           | Black Body Stainless | Blue Body Stainless | Black Body Brass                                | Red Body Brass | Green Body Brass | Brass - Blue Body | Stainless - Blue Body |
| Part No | 202300470                  | 202700350            | 202700355           | 202300302                                       | 202300303      | 202300304        | 202300308         | 202700305             |



|         | Suttner KW Spigot                  |               |               | Budget KW Spigot | Kranzle Mini Spigot |
|---------|------------------------------------|---------------|---------------|------------------|---------------------|
| Inlet   | Polished Finish 1/4" F Full Thread | 1/4" F Thread | 1/4" M Thread | 1/4" F Thread    | 1/4" F Thread       |
| Part No | 040001248                          | 040001255     | 040001256     | TEC002           | 040001209           |

Hobby/Domestic Bayonet Adaptors



|         | Bayonet for Karcher Domestic Machines | Bayonet for Karcher Domestic Machines | Bayonet for KEW/Alto Machines | Bayonet for Nilfisk/Alto Machines | Bayonet for Bosch/Wap Machines | Bayonet for Lavor Machines | Bayonet for Annovi Machines |
|---------|---------------------------------------|---------------------------------------|-------------------------------|-----------------------------------|--------------------------------|----------------------------|-----------------------------|
| Inlet   | 1/4" F                                | 1/4" F                                | 1/4" F                        | 1/4" F                            | 1/4" F                         | 1/4" F                     | 1/4" F                      |
| Part No | 200000436                             | 200000435                             | 55920                         | 200000439                         | 55921                          | TPLAVBP                    | 200000438                   |
| O'Rings |                                       |                                       | 050000160                     |                                   | 559211                         | 050000160                  |                             |



|         | Karcher Hobby Bayonet Coupling Fits 200000435 & 6 | ST146 M22F Adaptor to fit K ServoPress | M22F Adaptor to fit Servopress | Kew Hobby Coupling x Karcher Style Bayonet | Kew Hobby Coupling x M22M | Kew Hobby Coupling x Annovi Probe | Kew Hobby Coupling x Bosch Probe |
|---------|---|--|--------------------------------|--|---------------------------|-----------------------------------|----------------------------------|
| Inlet   | 1/4" F  | 1/4" F                                 | 1/4" F                         | Kew Coupling                               | Kew Coupling              | Kew Coupling                      | Kew Coupling                     |
| Part No | 200000440   | 200146500                              | 56567                          | 55955                                      | 55956                     | 55958                             | 55959                            |

## GUNS & LANCES

### Suttner Foot Operated Valves



|                | ST540 Powder Coated |                                       |                                       | ST550 Stainless Steel |                      |
|----------------|---------------------|---------------------------------------|---------------------------------------|-----------------------|----------------------|
|                | Body Only           | 350bar Version fitted with ST2605 Gun | 500bar Version fitted with ST2750 Gun | 500bar Version 1/4"   | 500bar version       |
| <b>Part No</b> | 200540350           | 200540500                             | 200540550                             | 200550600             | 200550620            |
| <b>Rating</b>  | -                   | 350bar, 45lpm, 150°C                  | 500bar, 30lpm, 150°C                  | 500bar, 80lpm, 150°C  | 500bar, 80lpm, 150°C |
| <b>Inlet</b>   | -                   | 3/8" F                                | 3/8" F                                | 1/4" F                | M22M                 |
| <b>Outlet</b>  | -                   | 1/4" M                                | 1/4" M                                | 1/4" F                | M22F                 |

### Lance Holders



|                | Wall Mounted Stainless Gun & Lance Holder | Stainless Steel for 1 Lance | Stainless Steel for 3 Lances | Stainless Steel for 5 Lances | Plastic Holder for 3 Lances |
|----------------|---|-----------------------------|------------------------------|------------------------------|-----------------------------|
| <b>Part No</b> | 040002055                                 | TPLH1                       | TPLH3                        | 040003830                    | 020000970                   |

### Other Lance Accessories



| 110mm Deep Wall Bracket | Lance Splashguard | Inline Stainless Handle with 20° Bend | Thermometer for 1/4" Lances |
|-------------------------|-------------------|---------------------------------------|-----------------------------|
| 110 x 10mm              | 370mm x Ø200mm    | 1/4" M x 1/4" F, 350bar               | 0-120°C                     |
| 710400097               | 200029351         | 200009655                             | 200097425                   |



# NOZZLES & WASHING ACCESSORIES

|   |            |
|---|------------|
| <b>Nozzle Selection Chart</b>             | <b>92</b>  |
| <b>Spraying Systems Nozzles</b>           | <b>93</b>  |
| <b>1/8", PMEG &amp; VV Nozzles</b>        | <b>94</b>  |
| <b>Lechler, Vario &amp; Steam Nozzles</b> | <b>95</b>  |
| <b>Turbo Nozzles</b>                      | <b>96</b>  |
| <b>Hydroblade &amp; Dust Suppression</b>  | <b>97</b>  |
| <b>Quick Release Nozzles</b>              | <b>98</b>  |
| <b>Nozzle Protectors</b>                  | <b>99</b>  |
| <b>Adjustable Nozzle Holders</b>          | <b>100</b> |
| <b>Wash Brushes</b>                       | <b>101</b> |
| <b>Rotary Floor Cleaners</b>              | <b>102</b> |
| <b>Wall &amp; ST97 Floor Cleaners</b>     | <b>103</b> |
| <b>Sand Blasters &amp; Mud Suckers</b>    | <b>104</b> |
| <b>Tank Cleaning Nozzles</b>              | <b>105</b> |

# NOZZLES & WASHING ACCESSORIES

## PRESSURE IN BAR

|     | Ø    | 3    | 10   | 20   | 30   | 40   | 50   | 60   | 70   | 80    | 90    | 100   | 110   | 120   | 130   | 140   | 150   | 160   | 175   | 200   | 225   | 250   | 300   | 400   | 500   |
|-----|------|------|------|------|------|------|------|------|------|-------|-------|-------|-------|-------|-------|-------|-------|-------|-------|-------|-------|-------|-------|-------|-------|
| 01  | 0.59 | 0.4  | 0.7  | 1.0  | 1.3  | 1.4  | 1.6  | 1.7  | 1.8  | 2.0   | 2.1   | 2.2   | 2.3   | 2.4   | 2.5   | 2.6   | 2.7   | 2.8   | 2.9   | 3.1   | 3.3   | 3.5   | 3.8   | 4.4   | 4.9   |
| 015 | 0.71 | 0.6  | 1.0  | 1.5  | 1.8  | 2.1  | 2.4  | 2.6  | 2.8  | 3.0   | 3.2   | 3.4   | 3.6   | 3.7   | 3.8   | 4.0   | 4.2   | 4.3   | 4.5   | 4.8   | 5.1   | 5.4   | 5.9   | 6.7   | 7.5   |
| 02  | 0.84 | 0.8  | 1.4  | 2    | 2.5  | 2.8  | 3.2  | 3.5  | 3.7  | 4.0   | 4.2   | 4.5   | 4.7   | 4.8   | 5.0   | 5.3   | 5.4   | 5.6   | 5.9   | 6.3   | 6.7   | 7.0   | 7.7   | 8.9   | 9.9   |
| 025 | 0.94 | 1.0  | 1.6  | 2.5  | 3.1  | 3.5  | 4.0  | 4.3  | 4.7  | 5.0   | 5.3   | 5.6   | 5.9   | 6.1   | 6.4   | 6.6   | 6.9   | 7.1   | 7.5   | 8.0   | 8.5   | 9.0   | 9.9   | 11.4  | 12.7  |
| 03  | 1.03 | 1.2  | 2.0  | 3.1  | 3.7  | 4.3  | 4.8  | 5.3  | 5.7  | 6.1   | 6.3   | 6.8   | 7.1   | 7.4   | 7.7   | 8.0   | 8.3   | 8.6   | 9.0   | 9.6   | 10.2  | 10.7  | 11.8  | 13.5  | 15.1  |
| 035 | 1.10 | 1.4  | 2.5  | 3.6  | 4.2  | 4.9  | 5.5  | 6.0  | 6.5  | 7.0   | 7.4   | 7.8   | 8.2   | 8.6   | 8.9   | 9.2   | 9.5   | 9.8   | 10.3  | 11.0  | 11.7  | 12.3  | 13.8  | 15.5  | 17.8  |
| 04  | 1.21 | 1.6  | 2.8  | 4.1  | 5.2  | 5.9  | 6.6  | 7.3  | 7.8  | 8.4   | 8.9   | 9.4   | 9.8   | 10.3  | 10.7  | 11.2  | 11.5  | 11.9  | 12.4  | 13.3  | 14.1  | 14.8  | 16.3  | 18.7  | 20.9  |
| 045 | 1.26 | 1.8  | 3.1  | 4.5  | 5.5  | 6.4  | 7.1  | 7.8  | 8.4  | 9.0   | 9.6   | 10.2  | 10.5  | 10.9  | 11.4  | 11.8  | 12.2  | 12.6  | 13.2  | 14.1  | 15.0  | 15.8  | 17.4  | 19.9  | 22.3  |
| 05  | 1.33 | 2.0  | 3.5  | 5.1  | 6.2  | 7.1  | 8.0  | 8.7  | 9.4  | 10.0  | 10.7  | 11.3  | 11.8  | 12.4  | 12.9  | 13.4  | 13.8  | 14.3  | 14.9  | 16.0  | 16.9  | 17.9  | 19.7  | 22.6  | 25.3  |
| 055 | 1.39 | 2.2  | 3.7  | 5.6  | 6.8  | 7.8  | 8.7  | 9.6  | 10.3 | 11.1  | 11.8  | 12.4  | 13.0  | 13.6  | 14.1  | 14.7  | 15.2  | 15.7  | 16.4  | 17.5  | 18.6  | 19.6  | 21.7  | 25.0  | 28.0  |
| 06  | 1.46 | 2.4  | 4.1  | 6.1  | 7.4  | 8.6  | 9.6  | 10.4 | 11.3 | 12.1  | 12.8  | 13.6  | 14.3  | 14.9  | 15.5  | 16.0  | 16.7  | 17.2  | 18.0  | 19.2  | 20.4  | 21.5  | 23.7  | 27.1  | 30.3  |
| 065 | 1.52 | 2.6  | 4.3  | 6.6  | 8.0  | 9.3  | 10.4 | 11.3 | 12.3 | 13.2  | 14.0  | 14.7  | 15.4  | 16.1  | 16.8  | 17.4  | 18.0  | 18.6  | 19.4  | 20.8  | 22.0  | 23.2  | 25.6  | 29.3  | 32.7  |
| 07  | 1.57 | 2.8  | 5.0  | 7.1  | 8.6  | 10.0 | 11.2 | 12.2 | 13.2 | 14.1  | 15.0  | 15.8  | 16.6  | 17.3  | 18.0  | 18.7  | 19.3  | 20.0  | 20.9  | 22.3  | 23.7  | 25.0  | 27.1  | 31.3  | 35.0  |
| 075 | 1.63 | 3.0  | 5.3  | 7.6  | 9.3  | 10.7 | 12.0 | 13.1 | 14.2 | 15.2  | 16.1  | 16.9  | 17.7  | 18.5  | 19.3  | 20.0  | 20.7  | 21.4  | 22.4  | 23.9  | 25.3  | 26.7  | 29.4  | 33.7  | 37.7  |
| 08  | 1.68 | 3.2  | 5.6  | 8.2  | 9.8  | 11.3 | 12.7 | 14.0 | 15.1 | 16.1  | 17.1  | 18.0  | 18.9  | 19.7  | 20.5  | 21.3  | 22.0  | 22.8  | 23.8  | 25.5  | 27.0  | 28.5  | 31.4  | 35.9  | 40.2  |
| 085 | 1.73 | 3.4  | 6    | 8.7  | 10.4 | 12.1 | 13.5 | 14.8 | 16.0 | 17.1  | 18.1  | 19.1  | 20.0  | 20.9  | 21.8  | 22.6  | 23.4  | 24.1  | 25.3  | 27.0  | 28.6  | 30.2  | 34.5  | 39.8  | 44.5  |
| 09  | 1.78 | 3.6  | 6.5  | 9.2  | 11.1 | 12.8 | 14.3 | 15.7 | 17.0 | 18.0  | 19.2  | 20.2  | 21.2  | 22.1  | 23.0  | 23.9  | 24.7  | 25.5  | 26.7  | 28.6  | 30.3  | 31.9  | 35.1  | 40.2  | 45.0  |
| 10  | 1.88 | 3.9  | 7.0  | 10.2 | 12.3 | 14.2 | 16.0 | 17.4 | 18.9 | 20.1  | 21.4  | 22.5  | 23.6  | 24.6  | 25.6  | 26.6  | 27.6  | 28.5  | 29.8  | 31.8  | 33.7  | 35.6  | 39.2  | 44.9  | 50.2  |
| 11  | 1.96 | 4.3  | 7.8  | 11.2 | 13.4 | 15.5 | 17.3 | 19.0 | 20.5 | 22.0  | 23.3  | 24.5  | 25.7  | 26.9  | 28.0  | 29.1  | 30.1  | 31.1  | 32.5  | 34.7  | 36.8  | 38.8  | 43.4  | 50.1  | 56.0  |
| 12  | 2.05 | 4.7  | 8.4  | 12.3 | 14.6 | 16.9 | 18.9 | 20.8 | 22.4 | 24.0  | 25.4  | 26.8  | 28.1  | 29.4  | 30.6  | 31.7  | 32.8  | 33.9  | 35.4  | 37.9  | 40.2  | 42.4  | 46.7  | 53.4  | 59.8  |
| 13  | 2.13 | 5.1  | 9.5  | 13.3 | 15.9 | 18.3 | 20.5 | 22.5 | 24.3 | 26.0  | 27.5  | 29.0  | 30.4  | 31.8  | 33.1  | 34.4  | 35.6  | 36.7  | 38.4  | 41.1  | 43.6  | 45.9  | 50.5  | 57.8  | 64.7  |
| 14  | 2.21 | 5.5  | 10.2 | 14.3 | 17.1 | 19.7 | 22.1 | 24.2 | 26.1 | 28.0  | 29.6  | 31.3  | 32.8  | 34.2  | 35.6  | 37.0  | 38.3  | 39.5  | 41.4  | 44.3  | 46.9  | 49.4  | 55.0  | 63.5  | 71.0  |
| 15  | 2.30 | 5.9  | 10.8 | 15.3 | 18.5 | 21.3 | 23.9 | 26.1 | 28.3 | 30.2  | 32.1  | 33.8  | 35.3  | 36.9  | 38.4  | 39.9  | 41.3  | 42.6  | 44.6  | 47.7  | 50.6  | 53.3  | 58.7  | 67.2  | 75.2  |
| 20  | 2.66 | 7.9  | 14   | 20.5 | 24.7 | 28.5 | 31.9 | 34.9 | 37.8 | 40.3  | 42.7  | 45.1  | 47.2  | 49.3  | 51.3  | 53.2  | 55.1  | 56.9  | 59.5  | 63.6  | 67.5  | 71.1  | 78.2  | 89.6  | 100.0 |
| 30  | 3.25 | 11.8 | 21.1 | 31.0 | 37.0 | 42.7 | 47.8 | 52.4 | 56.6 | 60.5  | 64.2  | 67.6  | 70.9  | 74.0  | 77.1  | 80.0  | 82.8  | 85.5  | 89.4  | 95.6  | 101.0 | 107.0 | 118.0 | 149.0 | 151.0 |
| 40  | 3.76 | 15.8 | 28.0 | 41.0 | 49.4 | 57.0 | 63.7 | 69.8 | 75.4 | 80.7  | 85.5  | 90.2  | 94.6  | 98.8  | 103.0 | 107.0 | 110.0 | 114.0 | 119.0 | 127.0 | 135.0 | 143.0 | 157.0 | 198.0 | 202.0 |
| 50  | 4.28 | 19.7 | 35.3 | 51.0 | 61.5 | 71.0 | 80.0 | 87.0 | 94.5 | 102.5 | 107.0 | 112.5 | 118.0 | 123.0 | 128.0 | 133.0 | 138.0 | 142.5 | 149.0 | 159.0 | 168.5 | 178.0 | 196.0 | 224.5 | 251.0 |

## NOZZLE SIZE

## FLOW RATE (lpm)

Spraying Systems Nozzles



**Spraying Systems Co.**

Range of Spraying Systems nozzles with either 1/4" M (MEG) thread or flat faced tip (EG) style.



1/4" MEG

| Size | Inlet    | 0°    | 15°     | 25°     | 40°   | 65°   |
|------|----------|-------|---------|---------|-------|-------|
| 015  | 1/4" MEG |       | 15015ss |         |       |       |
| 02   | 1/4" MEG | 61005 | 61305   | 61750   | 62030 | 62520 |
| 025  | 1/4" MEG | 61007 | 61307   | 61765   | 62035 | 62525 |
| 03   | 1/4" MEG | 61010 | 61310   | 61770   | 62100 | 62530 |
| 035  | 1/4" MEG | 61020 | 15035ss | 25035ss | 62120 |       |
| 04   | 1/4" MEG | 61030 | 61330   | 61790   | 62130 | 62540 |
| 045  | 1/4" MEG | 61040 | 15045ss | 25045ss | 62140 | 62550 |
| 05   | 1/4" MEG | 61050 | 15055ss | 25055ss | 62150 | 62560 |
| 055  | 1/4" MEG | 61060 | 15055ss | 25055ss | 62160 | 62570 |
| 06   | 1/4" MEG | 61070 | 15065ss | 25065ss | 62170 | 62580 |
| 065  | 1/4" MEG | 61080 | 61380   | 61840   | 62180 | 62590 |
| 07   | 1/4" MEG | 61090 | 61390   | 61850   | 62190 | 62600 |
| 075  | 1/4" MEG |       | 61400   | 61860   | 62200 |       |
| 08   | 1/4" MEG | 61110 | 61410   | 61870   | 62210 | 62610 |
| 085  | 1/4" MEG |       | 61420   |         |       |       |
| 09   | 1/4" MEG | 61130 | 61430   | 61890   | 62230 | 62620 |
| 10   | 1/4" MEG | 61140 | 61440   | 61900   | 62240 | 62630 |
| 11   | 1/4" MEG | 61150 | 61450   | 61910   | 62250 |       |
| 12   | 1/4" MEG | 61160 | 61460   | 61920   | 62260 |       |
| 12.5 | 1/4" MEG | 61165 | 61465   |         | 62270 |       |
| 13   | 1/4" MEG | 61170 | 61470   | 61930   |       |       |
| 14   | 1/4" MEG | 61175 | 61475   | 61935   |       |       |
| 15   | 1/4" MEG | 61180 | 61480   | 61940   | 62280 | 62650 |
| 20   | 1/4" MEG | 61190 | 61490   | 61950   | 62290 | 62660 |
| 25   | 1/4" MEG | 61200 | 61500   | 61960   | 62300 |       |
| 30   | 1/4" MEG | 61210 | 61510   | 61970   | 62320 | 62670 |
| 35   | 1/4" MEG | 61220 | 61520   | 61975   |       |       |
| 40   | 1/4" MEG | 61215 | 61525   | 61980   | 62330 | 62681 |
| 50   | 1/4" MEG | 61220 | 61535   | 61990   | 62332 |       |

Spray Angle Guide

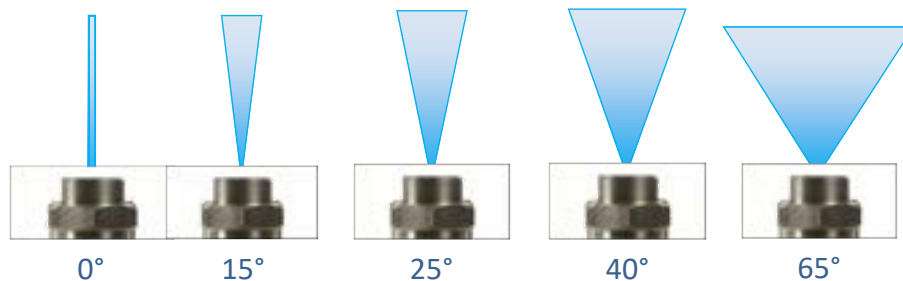

EG TIP

| Size | Inlet      | 0°    | 15°   | 25°   | 40°   | 65°    |
|------|------------|-------|-------|-------|-------|--------|
| 02   | EG TIP (K) |       |       |       |       | 609052 |
| 03   | EG TIP (K) | 60005 |       |       |       |        |
| 04   | EG TIP (K) | 60010 |       |       | 60760 |        |
| 045  | EG TIP (K) | 60020 |       |       | 60770 |        |
| 05   | EG TIP (K) | 60030 |       |       |       |        |
| 055  | EG TIP (K) | 60040 |       |       |       |        |
| 06   | EG TIP (K) | 60050 |       |       | 60800 |        |
| 065  | EG TIP (K) | 60060 | 60310 |       | 60810 |        |
| 07   | EG TIP (K) | 60070 |       |       | 60820 |        |
| 075  | EG TIP (K) |       | 60325 |       | 60825 |        |
| 08   | EG TIP (K) | 60080 | 60330 |       | 60830 |        |
| 09   | EG TIP (K) | 60100 | 60350 | 60600 | 60840 |        |
| 10   | EG TIP (K) |       | 60360 |       |       |        |
| 12   | EG TIP (K) |       | 60370 | 60620 |       |        |
| 13   | EG TIP (K) |       |       | 60630 | 60870 |        |
| 15   | EG TIP (K) |       | 60390 | 60640 |       |        |
| 20   | EG TIP (K) |       |       | 60650 | 60900 |        |

1/8" M Spraying Systems Nozzles



Range of Spraying Systems nozzles with 1/8" M (MEG) thread.

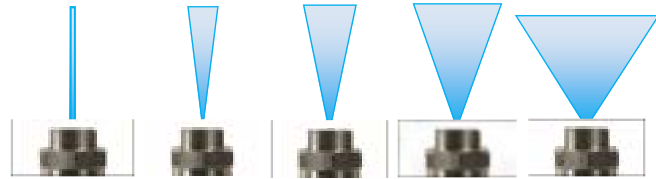

| Size | 0°    | 15°       | 25°   | 40°   | 65°      |
|------|-------|-----------|-------|-------|----------|
| 02   | 63008 | 63205     | 63500 |       | GS6502-8 |
| 025  |       | GS15026/8 |       |       |          |
| 03   | 63010 | 63210     | 63510 | 63810 | GS6503-8 |
| 035  |       | 63215     | 63515 |       |          |
| 04   | 63020 | 63220     | 63520 |       |          |
| 045  | 63030 | 63230     | 63530 | 63830 |          |
| 05   | 63040 | 63240     | 63540 |       | 63960    |
| 055  |       | 63250     | 63550 |       |          |
| 06   |       | 63260     | 63560 | 63860 |          |
| 065  | 63070 | 63270     | 63570 |       |          |
| 07   | 63080 | 63280     | 63580 |       |          |
| 075  |       | 63285     |       |       |          |
| 08   | 63100 | 63300     | 63600 |       |          |
| 10   | 63130 | 63330     | 63630 | 63930 | 63965    |
| 12   | 63150 |           |       |       |          |
| 15   |       |           | 63680 |       |          |

Spraying Systems PMEG & VV Nozzles

Range of Spraying Systems PMEG nozzles with either 1/4" M or 1/8" M threads. PMEG nozzles give 3x the impact of a standard jet.



Range of Spraying Systems VV nozzles with 1/8" & 1/4" M threads. The VV range of nozzles have an internal thread which will accept an inline filter (sold separately). These filters help reduce the risk of the nozzle blocking.



| Size | Thread | 15°    | 25°    |
|------|--------|--------|--------|
| 04   | 1/8" M | 632205 |        |
|      | 1/4" M | 613305 | 617905 |
| 045  | 1/8" M |        |        |
|      | 1/4" M | 613405 | 618005 |
| 05   | 1/8" M | 632405 |        |
|      | 1/4" M | 613505 | 618105 |
| 055  | 1/8" M | 632505 |        |
|      | 1/4" M | 613605 | 618205 |
| 06   | 1/8" M | 632605 |        |
|      | 1/4" M | 613705 | 618305 |
| 065  | 1/8" M | 632705 |        |
|      | 1/4" M | 613805 | 618405 |

| Size | Thread | 15°    | 25°    | 40°   | 65°          | 80°     | 110°   |
|------|--------|--------|--------|-------|--------------|---------|--------|
| 0033 | 1/8" M |        |        |       |              |         |        |
|      | 1/4" M |        |        |       | GS650033VV/4 |         |        |
| 01   | 1/8" M |        |        | 63801 |              |         | 63979  |
|      | 1/4" M | 1501ss | 2501ss | 62020 | 62510        | 6270001 |        |
| 015  | 1/8" M |        |        |       |              |         | 63980  |
|      | 1/4" M |        |        | 62025 | 62515        | 62700   |        |
| 02   | 1/8" M |        |        |       | 63957        |         | 63982  |
|      | 1/4" M |        |        |       |              | 62702   |        |
| 03   | 1/8" M |        |        |       |              |         |        |
|      | 1/4" M |        |        |       |              |         | 628003 |

| Filters to fit | 1/8" M | 64995 |
|----------------|--------|-------|
|                | 1/4" M | 64990 |



Foam Nozzles



Range of Spraying Systems foam nozzles with either 3/8" M or 1/2" M threads.



| Thread | Nozzle Size | Brass      | Stainless Steel |
|--------|-------------|------------|-----------------|
| 3/8" M | 40°150      | GS40150B38 | 623401509       |
| 3/8" M | 50°120      |            | 6241209         |
| 3/8" M | 65°150      |            | GS65150ss38     |
| 1/2" M | 50°200      | 5028031    |                 |
| 1/2" M | 65°100      | 120651002B |                 |
| 1/2" M | 65°200      |            | 12065200ss      |
| 1/2" M | 80°200      | 120802002B | 120802002       |

Lechler Nozzles



Range of Lechler nozzles with either a 1/4" Male thread or the flat faced (K) tip style.

Spray Angle Guide

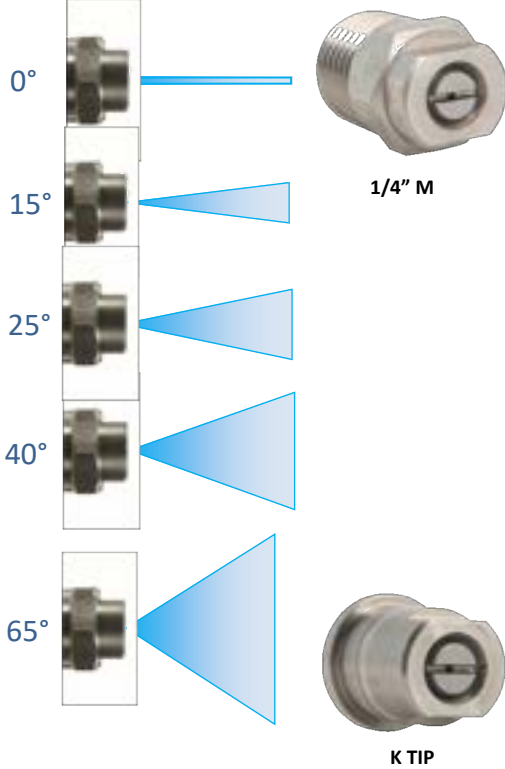

| Size | Inlet  | 0°    | 15°   | 25°   | 40°   | 65°   |
|------|--------|-------|-------|-------|-------|-------|
| 02   | 1/4" M |       | 1502  |       |       |       |
| 025  | 1/4" M |       | 15025 | 25025 |       |       |
| 03   | 1/4" M |       | 1503  | 2503  |       | 6503  |
| 034  | 1/4" M |       | 15034 | 25034 |       | 62535 |
| 04   | 1/4" M |       | 1504  | 2504  |       |       |
| 045  | 1/4" M | 00045 | 15045 | 25045 | 40045 |       |
| 05   | 1/4" M |       | 1505  | 2505  |       |       |
| 055  | 1/4" M | 00055 | 15055 | 25055 |       |       |
| 06   | 1/4" M |       | 1506  | 2506  |       |       |
| 065  | 1/4" M |       | 15065 |       |       |       |
| 07   | 1/4" M |       | 1507  |       |       |       |
| 075  | 1/4" M |       | 15075 |       |       |       |
| 08   | 1/4" M |       | 1508  |       |       |       |
| 09   | 1/4" M |       | 1509  |       |       |       |
| 10   | 1/4" M | 0010  | 1510  |       |       |       |
| 15   | 1/4" M |       | 1515  |       |       |       |
| 30   | 1/4" M |       |       |       | 4030  |       |

| Size | Inlet   | 0°     | 15°    | 25°    | 40°    | 65°    |
|------|---------|--------|--------|--------|--------|--------|
| 02   | TIP (K) |        | 1502T  |        |        |        |
| 025  | TIP (K) |        |        |        |        |        |
| 03   | TIP (K) |        | 1503T  | 2503T  |        |        |
| 034  | TIP (K) |        |        | 25035T |        | 65034T |
| 04   | TIP (K) |        | 1504T  | 2504T  |        |        |
| 045  | TIP (K) | 00045T | 15045T | 25045T |        |        |
| 05   | TIP (K) |        | 1505T  | 2505T  | 4005T  |        |
| 055  | TIP (K) | 00055T | 15055T | 25055T | 40055T |        |
| 06   | TIP (K) |        | 1506T  | 2506T  |        |        |
| 065  | TIP (K) |        |        | 25065T |        |        |
| 07   | TIP (K) |        | 1507T  | 2507T  |        |        |
| 08   | TIP (K) | 0008T  |        |        |        |        |

Vario, Trable, Air & Steam Nozzles



| Nozzle Size | Inlet  | Vario Nozzle<br>200 bar, 150°C |         | Treble Nozzle<br>250 bar, 80°C |         |
|-------------|--------|--------------------------------|---------|--------------------------------|---------|
|             |        | Dot Colour                     | Part No | Colour                         | Part No |
| 03          | 1/4" F | Yellow                         | 6581030 |                                |         |
| 035         | 1/4" F | White                          | 6581035 |                                |         |
| 04          | 1/4" F | Blue                           | 6581040 |                                |         |
| 045         | 1/4" F | Orange                         | 6581045 | Blue                           | 657545  |
| 05          | 1/4" F | Green                          | 658105  |                                |         |
| 055         | 1/4" F | Black                          | 6581055 | Red                            | 657555  |
| 06          | 1/4" F | Grey                           | 658106  | Green                          | 657560  |

| Aluminium Air Drying Nozzle | Brass Steam Nozzle |
|-----------------------------|--------------------|
| 10 bar, 1/4" M              | 10 bar, 1/4" F     |
| GS727A                      | PASN14             |

Suttner Turbo Nozzles



| Nozzle Size | ST357.1<br>100-250 bar, 100°C |            | ST458<br>200-400 bar, 100°C |            | ST458.1<br>120-250 bar, 100°C |            | ST559<br>300-600 bar, 90°C |            |
|-------------|-------------------------------|------------|-----------------------------|------------|-------------------------------|------------|----------------------------|------------|
|             | Nozzle                        | Repair Kit | Nozzle                      | Repair Kit | Nozzle                        | Repair Kit | Nozzle                     | Repair Kit |
| 03          | 200357530                     | 200357232  | 200458630                   | 200458230  |                               |            | 200559530                  | 200559130  |
| 035         | 200357535                     | 200357237  | 200458635                   | 200458235  |                               |            |                            |            |
| 04          | 200357540                     | 200357242  | 200458640                   | 200458240  |                               |            | 200559540                  | 200559140  |
| 045         | 200357545                     | 200357247  | 200458645                   | 200458245  |                               |            |                            |            |
| 05          | 200357550                     | 200357252  | 200458650                   | 200458250  |                               |            | 200559550                  | 200559150  |
| 055         | 200357555                     | 200357257  | 200458655                   | 200458255  |                               |            | 200559555                  | 200559155  |
| 06          | 200357560                     | 200357262  | 200458660                   | 200458260  |                               |            | 200559560                  | 200559160  |
| 065         | 200357565                     | 200357267  | 200458665                   | 200458265  |                               |            |                            |            |
| 07          | 200357570                     | 200357272  | 200458670                   | 200458270  |                               |            |                            |            |
| 08          | 200357580                     | 200357282  | 200458680                   | 200458280  |                               |            |                            |            |
| 09          | 200357590                     | 200357292  | 200458690                   | 200458190  |                               |            |                            |            |
| 10          | 200357510                     | 200357212  | 200458610                   | 200458110  |                               |            |                            |            |
| 11          |                               |            |                             |            | 200458811                     | 200458311  |                            |            |
| 12          |                               |            |                             |            | 200458812                     | 200458312  |                            |            |
| 13          |                               |            |                             |            | 200458813                     | 200458313  |                            |            |
| 15          |                               |            |                             |            | 200458815                     | 200458315  |                            |            |
| 18          |                               |            |                             |            | 200458818                     | 200458318  |                            |            |
| 20          |                               |            |                             |            | 200458820                     | 200458320  |                            |            |
| 25          |                               |            |                             |            | 200458825                     | 200458325  |                            |            |
| 30          |                               |            |                             |            | 200458830                     | 200458330  |                            |            |

Turbo Nozzle Accessories



| ST357 Spare Covers | Black   | Blue      | Yellow    | Green     | Red       | High Pressure Nozzle Filter |            |
|--------------------|---------|-----------|-----------|-----------|-----------|-----------------------------|------------|
|                    | Part No | 020007405 | 020007406 | 020007409 | 020007411 | 020007412                   | 1/4" F x M |

HACCP Compliant Coloured Lance Clips

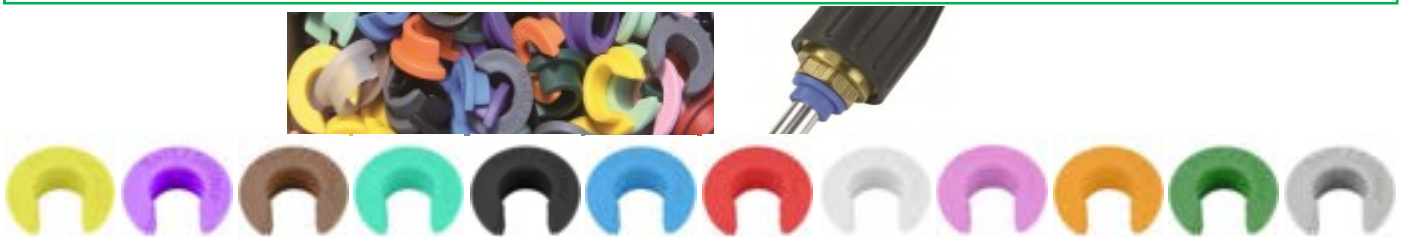

| Yellow    | Purple    | Brown     | Light Green | Black     | Blue      | Red       | Natural   | Pink      | Orange    | Dark Green | Grey      |
|-----------|-----------|-----------|-------------|-----------|-----------|-----------|-----------|-----------|-----------|------------|-----------|
| 020004230 | 020004235 | 020004240 | 020004245   | 020004250 | 020004255 | 020004260 | 020004265 | 020004270 | 020004280 | 020004290  | 020004300 |



Hydroblade Nozzle System to fit Karcher



Set of 6 nozzles complete with a lance holder



| Nozzle Size | 0°        | 15°       | 25°       | 40°       |
|-------------|-----------|-----------|-----------|-----------|
| 034         |           | 126015034 | 126025034 |           |
| 04          | 126100040 | 126015040 | 126025040 | 126040040 |
| 045         | 126100045 | 126015045 | 126025045 | 126040045 |
| 05          | 126100050 | 126015050 | 126025050 | 126040050 |
| 055         | 126100055 | 126015055 | 126025055 | 126040055 |
| 06          | 126100060 | 126015060 | 126025060 | 126040060 |
| 07          |           | 126015070 | 126025070 | 126040070 |
| 075         | 126100075 | 126015075 | 126025075 |           |

| Hydroblade Nozzle Holder x 1/4" F | Hydroblade Nozzle Protector |
|-----------------------------------|-----------------------------|
| 200088125                         | 200146210                   |

Stainless Steel Misting & Dust Suppression Nozzles

For use in the disinfection, humidification, cooling, dust suppression, decontamination, odour control in agriculture, food and the construction industry. Ideal for high flow applications.



| 1/4" F x M15x1 | ST78 Micro Droplet Nozzles |           |
|----------------|----------------------------|-----------|
|                | Nozzle Size                | Part No   |
| 200078830      | 1.2mm                      | 200078412 |
|                | 1.5mm                      | 200078415 |
|                | 1.8mm                      | 200078418 |
|                | 2.0mm                      | 200078420 |
|                | 2.3mm                      | 200078423 |
|                | 2.5mm                      | 200078425 |
|                | 3.0mm                      | 200078430 |
|                | 3.5mm                      | 200078435 |

Plastic Misting & Dust Suppression Nozzles



This polyamide 1/4" M atomising spray nozzle has an 80° hollow cone spray pattern. It comes with a removable filter with a built in anti-drip non return valve cartridge.

Applications include livestock shed cooling, disinfection, outside/external cooling, dust suppression and irrigation and humidifying of greenhouses.

| Part No | Colour | Angle | Filter Size | 1 bar     | 2 bar     | 5 bar     | 7 bar     |
|---------|--------|-------|-------------|-----------|-----------|-----------|-----------|
| GSRDSN  | Red    | 80°C  | 200 mesh    | 2.00 l/hr | 2.99 l/hr | 4.75 l/hr | 5.58 l/hr |
| GSPDSN  | Purple | 80°C  | 100 mesh    | 7.28 l/hr | 11.1 l/hr | 18.0 l/hr | 21.3 l/hr |

Quick Release Nozzles



| Nozzle Size | 15°      | 25°      | 40°      | 65°     | Complete QR Nozzle Set<br>Inc: 5x Nozzles, Coupling & Holder |
|-------------|----------|----------|----------|---------|--|
| 03          | TPQN1503 | TPQN2503 | TPQN4003 |         | TPQNS3   |
| 035         | TPQN1535 | TPQN035  | TPQN4035 |         | TPQNS35  |
| 04          | TPQN154  | TPQN254  | TPQN104  |         | TPQNS04  |
| 045         | TPQN1545 | TPQN2545 | TPQN4045 |         | TPQNS45  |
| 05          | TPQN1505 | TPQN2505 | TPQN405  |         | TPQNS05  |
| 055         | TPQN155  | TPQN2555 | TPQN4055 |         | TPQNS055   |
| 06          | TPQN156  | TPQN256  | TPQN406  |         | TPQNS06  |
| 40          |          |          |          | TPQN654 |  |

MINI Quick Release Couplings



| Mini QR Coupling Brass | Mini QR Probe 1/4" F | Mini QR Probe 1/4" M | Mini QR Coupling Stainless Steel | Mini QR Probe 1/4" F Stainless Steel | Mini QR Probe 1/4" M Stainless Steel |
|------------------------|----------------------|----------------------|----------------------------------|--------------------------------------|--------------------------------------|
| TPQNC                  | TPQNN14F             | TPQNN14M             | TPQNCSS                          | TPQNN14FSS                           | TPQNN14MSS                           |

Other Nozzle Accessories



| 500mm Gutter Cleaning Attachment. M22M x Mini QRC | Nozzle Holder for 5 QR Nozzles | Mini QR Replacement 'O' Ring | Nozzle Cleaning Tool | High Pressure Nozzle Filter 1/4" M x 1/4" F |
|---|--------------------------------|------------------------------|----------------------|---|
| GUT135  | TPQNH                          | 050000650                    | 200049042            | 200033855                                   |

## NOZZLES & WASHING ACCESSORIES

### ST-11 HACCP Compliant Food Safe Plastic Nozzle Protectors



| Red       | Green     | Yellow    | White     | Blue      | Grey      | Black     |
|-----------|-----------|-----------|-----------|-----------|-----------|-----------|
| 020001121 | 020001122 | 020001123 | 020001124 | 020001149 | 020001157 | 020001158 |

### ST-10 Hard & Soft Coloured Nozzle Protectors



| Colour          | Black/Black | Black/Blue | Black/Red | Grey/Black | Grey/Blue | Orange/Black | Black/Green | Indigo/Blue |
|-----------------|-------------|------------|-----------|------------|-----------|--------------|-------------|-------------|
| Zinc Plated     | 200010500   | 200010510  | 200010520 | 200010530  |           |              |             |             |
| Stainless Steel | 200010700   | 200010710  | 200010720 | 200010730  | 200010740 | 200010755    | 200010760   | 200010770   |

### Rubber/Plastic Nozzle Protectors



| 1/8" ST10 Nozzle Holder | 1/8" 3 Part Nozzle Protector | 1/4" VV Jet Nozzle Holder | 1/4" 3 Part Nozzle Protector | 1/4" 3 Part Nozzle Protector Stainless | ST12 Hard Protector | Budget Nozzle Protector | Rubber Shroud Protector | 1/4" Stainless Steel Protector |
|-------------------------|------------------------------|---------------------------|------------------------------|--|---------------------|-------------------------|-------------------------|--------------------------------|
| 200010830               | 200000004                    | 200010725                 | 200000003                    | 200000008                              | 200012500           | ST004D                  | 51905                   | 040004100                      |

### 1/4"F, Tip Nozzle & M18M Nozzle Holders



| 1/4"F Nozzle Socket | K Tip Holder 1/4"F x M18M Inc O'Ring | TR20 'K' Lock F x M18M Tip Holder | K Tip Cover M18F | M18F x 1/4"F Adaptor | M18F x 1/4"M Adaptor | TR20 'K' Lock Turbo Nozzle Adaptor 1/4"F |
|---------------------|--------------------------------------|-----------------------------------|------------------|----------------------|----------------------|--|
| 100001101           | 51950                                | 565686                            | 51960            | 51940                | 51970                | 565685                                   |

Adjustable Nozzle Holders



|         | ST51N Adjustable Nozzle | Mini Adjustable Nozzle | Adjustable Nozzle | ST52.1 Vario-Press |
|---------|-------------------------|------------------------|-------------------|--------------------|
| Rating  | 250bar, 90°C            | 250bar, 90°C           | 280bar, 90°C      | 250bar, 90°C       |
| Inlet   | 1/4" F                  | 1/4" F                 | 1/4" F            | 1/4" M             |
| Outlet  | 1/4" F                  | 1/4" F                 | 1/4" F            | 1/4" F             |
| Part No | 200051530               | 65720                  | 65730             | 200052500          |

ST330 Stainless Steel Swivel Nozzle Holder

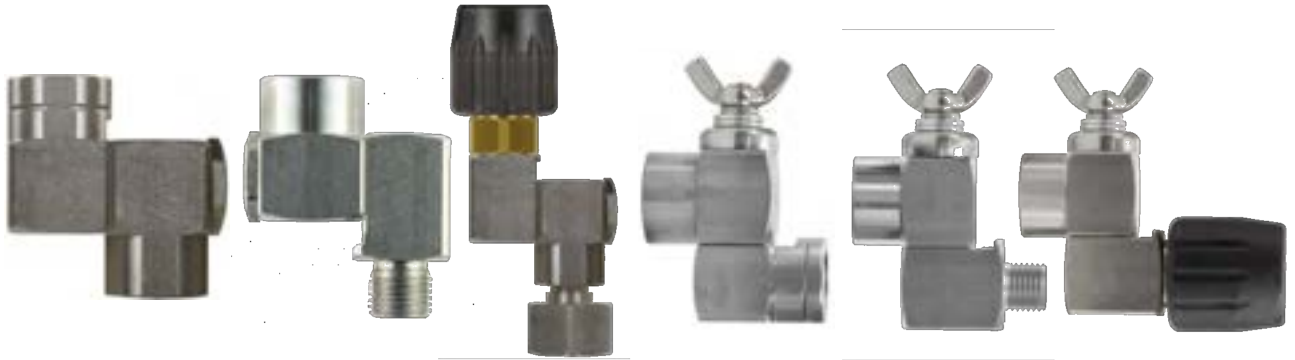

|                  | 1/4" F               | 1/4" F x 1/4" M      | M18F x Tip Nozzle    | Lockable 1/4" F      | Lockable 1/4" F x    | Lockable M18F x Tip  |
|------------------|----------------------|----------------------|----------------------|----------------------|----------------------|----------------------|
| Rating           | 310bar, 45lpm, 150°C | 310bar, 45lpm, 150°C | 310bar, 45lpm, 150°C | 310bar, 45lpm, 150°C | 310bar, 45lpm, 150°C | 310bar, 45lpm, 150°C |
| Standard Version | 200330500            | 200330510            | 200330600            | 200330501            | 200330511            | 200330521            |

Rollover, Twist & Pivoting Nozzle Holders



|                 | ST56 Rollover Twin Nozzle Holder | ST58 Change Over 1/4 Twist Valve | Pivoting Nozzle Holder |
|-----------------|----------------------------------|----------------------------------|------------------------|
| Rating          | 250bar, 30lpm, 90°C              | 350bar, 45lpm, 90°C              | 350bar, 40lpm, 90°C    |
| Inlet           | 1/4" F                           | 1/4" F                           | 1/4" M                 |
| Outlet          | 2 x 1/4" F                       | 2 x 1/4" F                       | 1/4" F                 |
| Brass           | 200056500                        |                                  |                        |
| Stainless Steel |                                  | 200058600                        | 519814140              |

Suttner Wash Brushes



| Bristle Length | ST23 Natural Bristle Brush 1/4" F.<br>Max 60°C | ST23 Natural & Synthetic Bristle Brush 1/4" F.<br>Max 60°C | Nylon Bristle Brush 1/4" F<br>Max 50°C |
|----------------|--|--|--|
| 60mm           | 200023550                                      |  | 52380                                  |
| 90mm           | 200023650                                      | 200023660  |  |

ERIE & Vorwerk Wash Brushes



| Bristle Length | ERIE Foam Master Brush<br>with Rubber Gasket. 1/2" F, Max 60°C | Vorwerk Brush with Nylon Bristles<br>1/4" F. Max 60°C | Vorwerk brush with Natural Bristles<br>1/4" F, Max 60°C |
|----------------|--|---|---|
| 60mm           |  | 523780  | 52370   |
| 90mm           |  |   | 52375   |
| 110mm          | GSERIEB  |   |   |

Poles for Wash Brushes



|        | ERIE Rubber Covered Wash Pole<br>3/8" F x 1/2" M Fits only onto ERIE Brush | Vorwerk Aluminium Lance. 1/4" F x M |
|--------|--|-------------------------------------|
| 1000mm | GSERIEH  | 5237901                             |
| 1500mm |  | 5237902                             |

Rotating Brushes



| Natural Bristle Brush | Natural Bristle Brush with Hinge | Nylon Bristle Brush | Nylon Bristle Brush with Hinge |
|-----------------------|----------------------------------|---------------------|--------------------------------|
| 1/4" M, 50bar, 50°C   | 1/4" M, 50bar, 50°C              | 1/4" F, 50bar, 50°C | 1/4" F, 50bar, 50°C            |
| 52210                 | 52250                            | 52230               | 52260                          |

## NOZZLES & WASHING ACCESSORIES

### Stainless Steel Rotary Wall Cleaners



|                   | 160mm Handheld Compact Wall Cleaner | 200mm Handheld Mosmatic Wall Cleaner | 300mm Wall Cleaner for Telescopic Lances |            |
|-------------------|-------------------------------------|--------------------------------------|--|------------|
| Rating            | 350bar, 90°C                        | 275bar, 120°C                        | 250bar, 90°C                             |            |
| Inlet             | M22M                                | M22M                                 | 1/4" F                                   | M22M       |
| Nozzle Req        | 2 x 1/4" M                          | 2 x 1/8" M                           | 2 x 1/4" M                               | 2 x 1/4" M |
| With Brush Skirt  | 710100160                           | 10878002                             | 521032257                                | 521032254  |
| With Rubber Skirt |                                     |                                      | 521032258                                | 521032251  |

### ST97 Specialist Cleaning Equipment



|         | ST97 400mm Stainless | 1700mm Underbody Wash Lance |           | 400mm ST97 Weed Devil. | 150mm ST97 Weed Devil |           |
|---------|----------------------|-----------------------------|-----------|------------------------|-----------------------|-----------|
| Inlet   | 1/4" M               | 1/4" M or 3/8" F            |           | 1/4" M                 | 1/4" M                |           |
| Nozzles | 4 x 80°015 Supplied  | 3 x 1/8" M Required         |           | 4 x 1/4" M Required    | Included              |           |
|         | 200097500            | (1/4" M)                    | 200097800 | 200097700              | 1/4" M + Lance        | 500097103 |
|         |                      | + ST601 (3/8" F)            | 200097801 |                        | 1/4" F Head Only      | 500097100 |

### Floor Cleaning Accessories

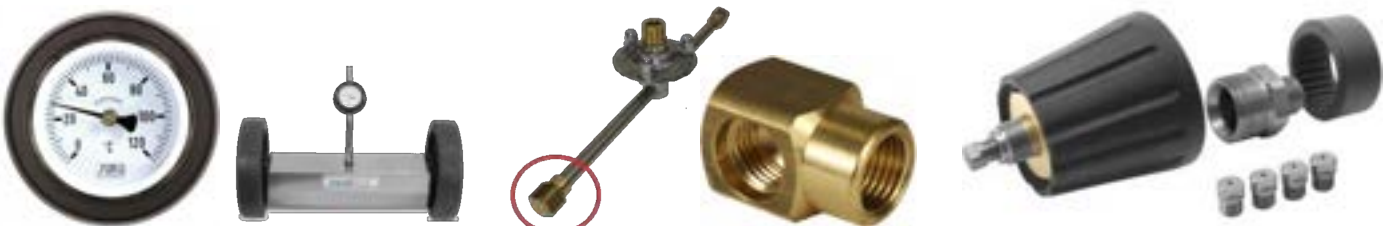

| Weed Devil Lance Thermometer | Turbo Devil ECO Nozzle Holder | Flow Restrictor<br>Inc 1.0, 1.1, 1.2, 1.3 & 1.4mm Nozzles |
|------------------------------|-------------------------------|---|
| 0-120°C                      | 1/4" F x 1/4" F               | 1/4" M x 1/4" M or M22F                                   |
| 200097420                    | 521052500NH                   | 200097750   |

Turbo Devil Industrial SS Rotary Surface Cleaners



| Width/Model        | 300mm<br>60°C | 420mm<br>120°C | 420mm                | 520mm                | 520mm + Swivel<br>Upgrade Kit | 520mm Agricultural<br>Version + Lance Holder | 750mm                |
|--------------------|---------------|----------------|----------------------|----------------------|-------------------------------|--|----------------------|
| Rating             | 275bar, 30lpm |                | 275bar, 30lpm, 120°C | 275bar, 30lpm, 120°C |                               | 275bar, 30lpm, 120°C                         | 275bar, 40lpm, 120°C |
| Wheel/Castor       | 3 x 60mm      |                | 3 x 60mm             | 3 x 60mm             |                               | 1 x  | 4 x 60mm             |
| Inlet              | 1/4" F        |                | 1/4" F               | 1/4" F               |                               | 1/4" F                                       | 1/4" F               |
| Nozzles Req        | 2 x 1/4" M    |                | 2 x 1/4" M           | 2 x 1/4" M           |                               | 2 x 1/4" M                                   | 3 x 1/4" M           |
| Part No            | 521030300     | 521042400      | 521042450            | 521052400            | 521052999                     | 521052900                                    | 521075300            |
| With Gun           |               |                |                      | 521052401            |                               |  | 521075301            |
| <b>Spare Parts</b> |               |                |                      |                      |                               |  |                      |
| Rotor Arm          | 10882683      | 521042495      | 521042495            | 10882975             | 10882975                      | 10882975                                     | 10882976             |
| Swivel Only        | 10835906      | 10835906       | 10838907             | 10838907             |                               | 10858553                                     | 10855907             |
| Castor             | 10880967      | 10880967       | 10880912             | 10880912             | 10880967                      |  | 108902483            |

For images of all of the products listed, please just visit our website: [www.gspen.co.uk](http://www.gspen.co.uk)

Turbo Devil Eco Rotary Surface Cleaners



| Width/Model  | RC301 - 300mm       | RC421 - 420mm       | RC521 - 520mm       | AGR520 - 520mm      | AGR800 - 800mm      |
|--------------|---------------------|---------------------|---------------------|---------------------|---------------------|
| Rating       | 250bar, 15lpm, 90°C | 250bar, 19lpm, 90°C | 275bar, 22lpm, 90°C | 250bar, 22lpm, 90°C | 350bar, 30lpm, 90°C |
| Part No      | 710100300           | 710100400           | 710100501           | 710100556           | 710100806           |
| Inlet        | M22M                | M22M                | 1/4" F              | 1/4" F              | 1/4" F              |
| Nozzles Req  | 2 x 1/4" M          | 2 x 1/4" M          | 2 x 1/4" M          | 2 x 1/4" M          | 4 x 1/4" M          |
| Swivel & Arm | 710100001           | 710100002           | 710100004           | 710100004           | 710100031           |
| Wheel/Castor | 710101477           | 710101477           | 710101375           |                     |                     |

Sand Blast Kits

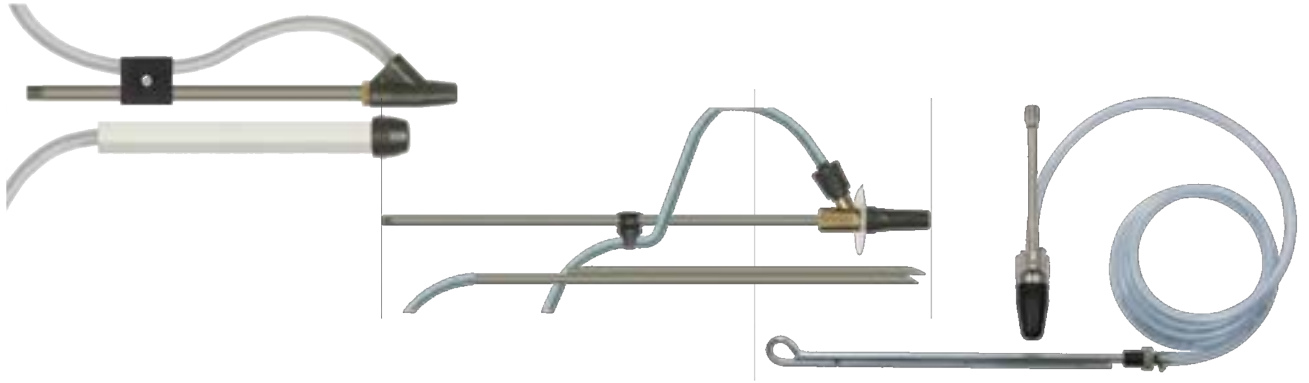

|            | ST355 - Hobby Sandblast Kit<br>Lance = 300mm, Hose = 3m | ST55 - Commercial<br>Lance = 600mm, Hose = 5m | ST555 - Industrial<br>Stainless Steel |
|------------|---|---|---------------------------------------|
| Rating     | 150bar  | 200bar,                                       | 500bar, 100°C                         |
| Grain Size | 0.2 - 0.8mm   | 0.2 - 0.8mm                                   | 0.4 - 0.8mm                           |
|            | 200355500   |   |                                       |
| 03         |   |   | 200555530                             |
| 04         |   | 5208240                                       | 200555540                             |
| 045        |   | 5208245                                       |                                       |
| 05         |   | 5208250                                       |                                       |
| 055        |   | 5208255                                       | 200555555                             |
| 06         |   | 5208260                                       |                                       |
| 065        |   | 5208265                                       | 200555565                             |
| 075        |   |   | 200555575                             |

ST36 Mudsuckers/Sludge Gulpers



| Pressure | Flow  | Capacity lpm | Capacity lph |
|----------|-------|--------------|--------------|
| 100bar   | 10lpm | 170          | 10,000       |
| 150bar   | 12lpm | 220          | 13,000       |
| 200bar   | 15lpm | 300          | 18,000       |

|     | ST36 inc 5m x 38mm Hose, M22M Inlet |
|-----|-------------------------------------|
| 04  | 5455040                             |
| 045 | 5455045                             |
| 05  | 5455050                             |
| 055 | 5455055                             |
| 06  | 5455060                             |
| 065 | 5455065                             |
| 07  | 5455070                             |
| 08  | 5455080                             |



| Replacement ST36 Body                       |
|---|
| Inlet = 3/8" F, Outlet = 1/4" F, H/T = 38mm |
| 200036490                                   |



**Mosmatic Duct Cleaning Nozzles**

These rotary cleaners from Mosmatic are ideal for cleaning ducts, tanks and other containers. Depending on the type of application, you can choose from a fixed arm or an adjustable arm version. The duct cleaner is equipped with a heavy duty stainless steel cage to help protect the rotor arms within.



| Ø      | TYR2s - Adjustable Arms | TYR2f - Fixed Arms |
|--------|-------------------------|--------------------|
| Rating | 275bar, 120°C           | 275bar, 120°C      |
| 75mm   | 10881502                | 10881402           |
| 150mm  | 10881522                | 10881422           |
| 300mm  | 10881552                | 10881452           |

**Tank Cleaning Nozzles**



|          | ST82 Self Rotating Tank Cleaner | ST82 Self Rotating Tank Cleaner | ST82 Powered Tank Cleaner<br>10m cable, 12v motor supplied by 230v |
|----------|---------------------------------|---------------------------------|--|
| Part No  | 200082600                       | 200082700                       | 200082500  |
| Coverage | 244°                            | 360°                            | 360°   |
| Inlet    | 1/2" F                          | 3/4" F                          | M22M   |
| Outlet   | 3 x 1/8" F                      | 4 x 1/4" F                      | Nozzles Included   |
| Rating   | 40-160bar, 20-30lpm, 90°C       | 30-160bar, 20-120lpm, 90°C      | 220bar, 21lpm, 90°C  |





# FOAM EQUIPMENT & ACCESSORIES

|  |            |
|--|------------|
| <b>ST73 Snow Foam Lances</b>           | <b>108</b> |
| <b>LS3 &amp; Snow Foam Adaptors</b>    | <b>109</b> |
| <b>Foam Nozzle Chart</b>               | <b>110</b> |
| <b>ST160 Foam Injectors</b>            | <b>111</b> |
| <b>ST164 Twin Foam Injectors</b>       | <b>112</b> |
| <b>ST167 Full Flow Foam Injectors</b>  | <b>113</b> |
| <b>ST168 Full Flow Injectors + Air</b> | <b>114</b> |
| <b>Foam Injector Spares</b>            | <b>115</b> |
| <b>ST72 &amp; ST75 Foam Lances</b>     | <b>116</b> |
| <b>ST76, ST175 &amp; ST75.2 Lances</b> | <b>117</b> |
| <b>Foam Guns &amp; Nozzles</b>         | <b>118</b> |
| <b>Other Chemical Injectors</b>        | <b>119</b> |
| <b>Tank Sprayers &amp; Foamers</b>     | <b>120</b> |

ST73 Snow Foam Lance Chart

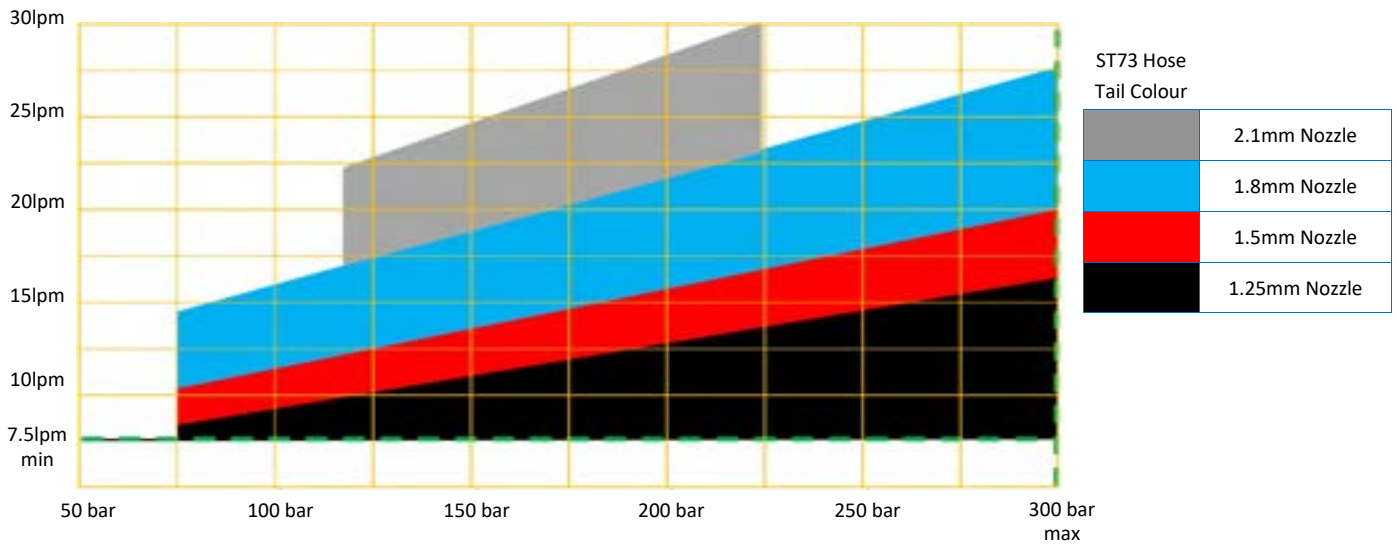

Snow Foam Lances

Dirty water constantly blocking your foam lance gauges? **Try the ST73.2**

Fitted with a cleanable filter mesh, instead of the stainless steel gauze as found in other foam lances, these lances will give you exceptional quality foam with prolonged usage, whatever your water quality. As with all of our foam lances, it is recommended that they are rinsed through with clean water after use.

Watch our maintenance videos on the G&S YouTube Channel



|          |       | ST73 + 1ltr Bottle   | ST73 + 2ltr Bottle   | ST73.2 w/o Foam Pad  |
|----------|-------|----------------------|----------------------|----------------------|
| Jet Size | HT    | 1/4" F, 300bar, 80°C | 1/4" F, 300bar, 80°C | 1/4" F, 300bar, 80°C |
| 1.25     | Black | 200073750            | 200073755            |                      |
| 1.5      | Red   | 200073900            |                      | 200073906            |
| 1.8      | Blue  |                      | 200073910            | 200073916            |
| 2.1      | Grey  |                      | 200073950            | 200073956            |

ST73 Spares & Accessories



| Replacement Foam Pads |           | Spare Bottles |           | Drinks Bottle Adaptor | Blue Bottle Top | Wall Bracket |
|-----------------------|-----------|---------------|-----------|-----------------------|-----------------|--------------|
| ST73 & LS3            | ST73.2    | 1ltr          | 2ltr      |                       |                 |              |
| GS25151251            | 020000606 | 020073513     | 020073520 | 020073530             | 020073522       | 200073425    |
|                       |           |               |           |                       |                 | 68mm x 95mm  |

Snow Foam Lance Connections



| 1/4" M Direct Attachment |                  |                   |           |           |              |
|--------------------------|------------------|-------------------|-----------|-----------|--------------|
| KW Spigot                | Mini QR Probe SS | Mini QR Probe Z.P | M22F      | M22M Long | 48mm SS Pipe |
| 040001256                | TPQNN14MSS       | TPQNN14M          | 200040510 | 565311    | 070000488    |



|                | Bayonet for Karcher Domestic Machines | Bayonet for Karcher Domestic Machines | Bayonet for KEW/Alto Machines | Bayonet for Nilfisk/Alto Machines | Bayonet for Bosch/Wap Machines | Bayonet for Lavor Machines | Bayonet for Annovi Machines |
|----------------|---------------------------------------|---------------------------------------|-------------------------------|-----------------------------------|--------------------------------|----------------------------|-----------------------------|
| <b>Inlet</b>   | 1/4" F                                | 1/4" F                                | 1/4" F                        | 1/4" F                            | 1/4" F                         | 1/4" F                     | 1/4" F                      |
| <b>Part No</b> | 200000436                             | 200000435                             | 55920                         | 200000439                         | 55921                          | TPLAVBP                    | 200000438                   |

Other Foam Lances

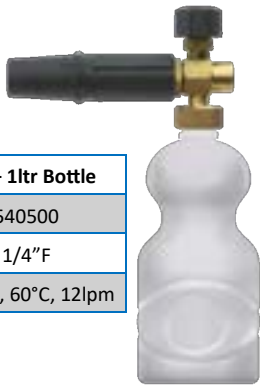

|                |                     |
|----------------|---------------------|
| <b>Model</b>   | LS3 + 1ltr Bottle   |
| <b>Part No</b> | 540500              |
| <b>Inlet</b>   | 1/4" F              |
| <b>Rating</b>  | 180bar, 60°C, 12lpm |

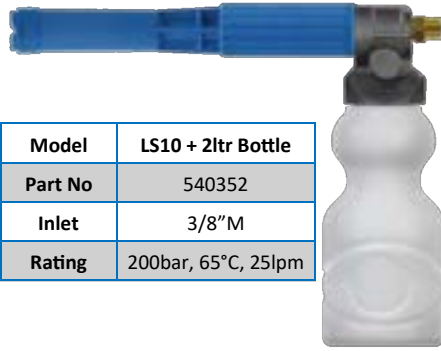

|                |                     |
|----------------|---------------------|
| <b>Model</b>   | LS10 + 2ltr Bottle  |
| <b>Part No</b> | 540352              |
| <b>Inlet</b>   | 3/8" M              |
| <b>Rating</b>  | 200bar, 65°C, 25lpm |



|                |                     |
|----------------|---------------------|
| <b>Model</b>   | LS10                |
| <b>Part No</b> | 54030               |
| <b>Inlet</b>   | 3/8" M              |
| <b>Rating</b>  | 200bar, 65°C, 25lpm |

Mains Powered Foam Lance



| Dial | Mix Ratio |
|------|-----------|
| A    | 1:128     |
| B    | 1:64      |
| C    | 1:32      |
| D    | 1:20      |
| E    | 1:10      |
| 0    | OFF       |

|                         |
|-------------------------|
| <b>Mains Foam Lance</b> |
| 106996500               |



ST160 Foam Injectors & Suitable Foam Lances



| Jet Size | ST160 + Fixed Metering Tips | ST160 + Adjustable Metering Valve | Suitable ST75 Foam Lance | Suitable Stainless Steel ST75 | Suitable ST76 Foam Blaster Lance |
|----------|-----------------------------|-----------------------------------|--------------------------|-------------------------------|----------------------------------|
| Thread   | 3/8" F In, 3/8" M Out       | 3/8" F In, 3/8" M Out             | 1/4" F                   | 1/4" F                        | 1/2" F                           |
| 1.2mm    | 200160499                   | 200160600                         | 200075574                |                               |                                  |
| 1.3mm    | 200160500                   | 200160601                         | 200075576                |                               |                                  |
| 1.4mm    | 200160505                   | 200160602                         | 200075577                |                               |                                  |
| 1.5mm    | 200160510                   | 200160603                         | 200075572                |                               |                                  |
| 1.6mm    | 200160515                   | 200160604                         | 200075572                | 200075514                     |                                  |
| 1.7mm    | 200160520                   | 200160605                         | 200075573                | 200075515                     |                                  |
| 1.8mm    | 200160525                   | 200160606                         | 200075578                | 200075516                     |                                  |
| 1.9mm    | 200160530                   | 200160607                         | 200075578                | 200075516                     |                                  |
| 2.0mm    | 200160535                   | 200160608                         |                          |                               | 200076615                        |
| 2.1mm    | 200160540                   | 200160609                         |                          |                               | 200076615                        |
| 2.2mm    | 200160545                   | 200160610                         |                          |                               | 200076615                        |
| 2.3mm    | 200160550                   | 200160611                         |                          |                               | 200076618                        |
| 2.5mm    | 200160560                   | 200160613                         |                          |                               | 200076621                        |
| 2.8mm    | 200160575                   | 200160614                         |                          |                               | 200076630                        |

System Set-up Diagram

**ST160 Specification:** Min - 8lpm, 80 bar  
 Max - 80lpm, 350 bar  
 Inlet - 3/8" F  
 Outlet - 3/8" M

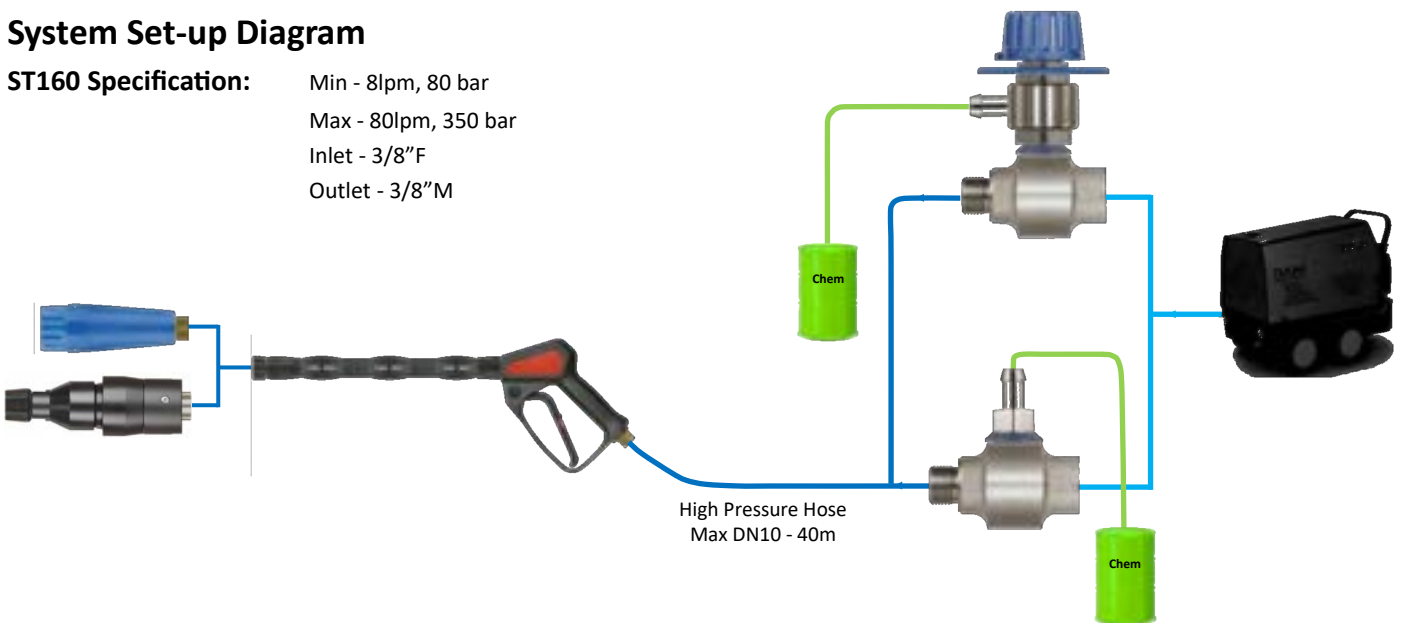

ST164 Twin Chemical Foam Injectors



Mounting Bracket

200168420



| Jet Size | ST164 + Fixed Metering Tips<br>No Air | ST164 + Compressed Air Module + Fixed<br>Metering Tips | ST164 + Air Module + Adjustable<br>Metering Valves |
|----------|---------------------------------------|--|--|
| Thread   | 1/2" F                                | 1/2" F   | 1/2" F   |
| 1.3mm    | 200164500                             | 200164580  | 200164600  |
| 1.4mm    | 200164502                             | 200164582  | 200164602  |
| 1.5mm    | 200164503                             | 200164583  | 200164603  |
| 1.6mm    | 200164504                             | 200164584  | 200164604  |
| 1.7mm    | 200164505                             | 200164585  | 200164605  |
| 1.8mm    | 200164506                             | 200164586  | 200164606  |
| 1.9mm    | 200164507                             | 200164587  | 200164607  |
| 2.0mm    | 200164508                             | 200164588  | 200164608  |
| 2.1mm    | 200164509                             | 200164589  | 200164609  |
| 2.2mm    | 200164510                             | 200164590  | 200164610  |
| 2.3mm    | 200164511                             | 200164591  | 200164611  |
| 2.4mm    | 200164512                             | 200164592  | 200164612  |
| 2.5mm    | 200164513                             | 200164593  | 200164613  |
| 2.8mm    | 200164514                             | 200164594  | 200164614  |

System Set-up Diagram

**ST164 Specification:**  
 Min - 8lpm, 80 bar  
 Max - 80lpm, 350 bar  
 Inlet - 1/2" F  
 Outlet - 1/2" F

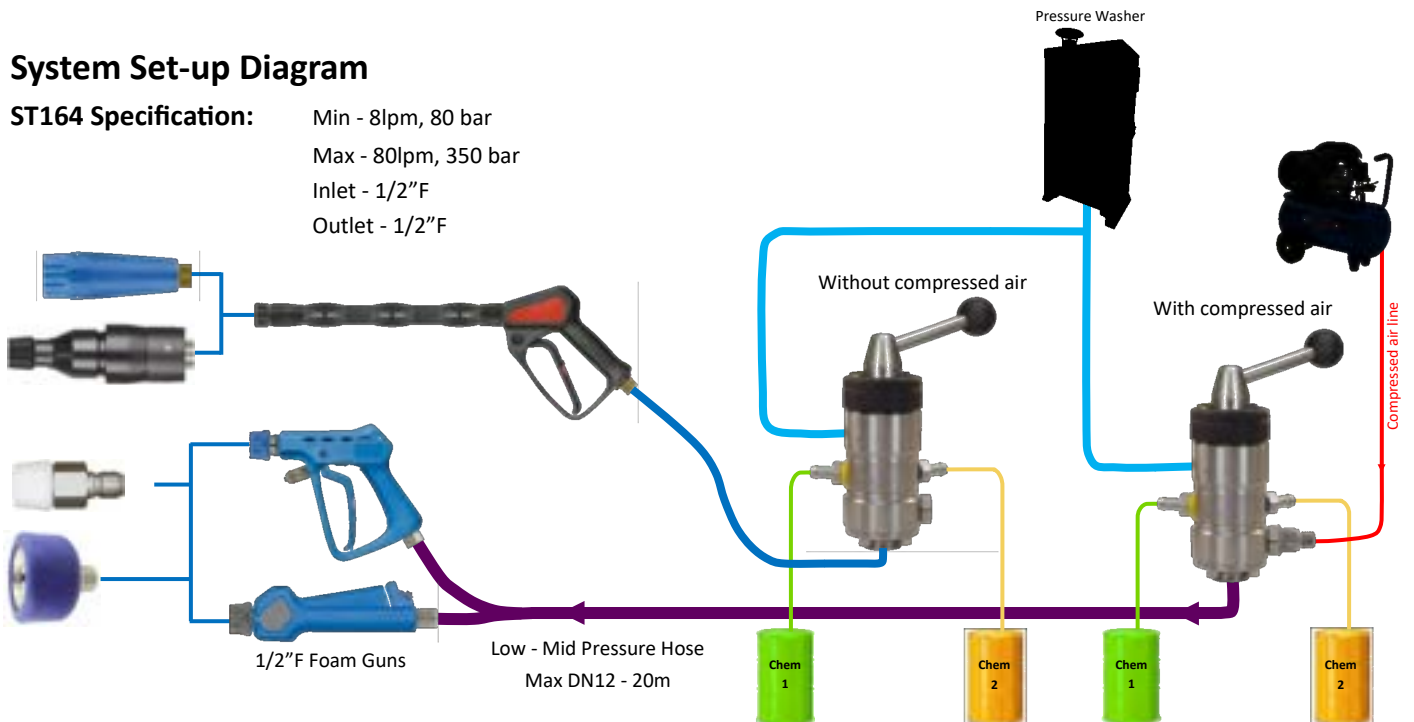



ST167 Full Flow Foam Injectors



Mounting Bracket

200168420



| Jet Size | ST167 + Fixed Metering Tips | ST167 + Adjustable Metering Valve | Suitable ST75 Foam Lance | Stainless Steel ST75 | Suitable ST76 Foam Blaster |
|----------|-----------------------------|-----------------------------------|--------------------------|----------------------|----------------------------|
| Thread   | 1/2" F                      | 1/2" F                            | 1/4" F                   | 1/4" F               | 1/2" F                     |
| 1.3mm    | 200167501                   | 200167601                         | 200075576                |                      |                            |
| 1.4mm    | 200167502                   | 200167602                         | 200075577                |                      |                            |
| 1.5mm    | 200167503                   | 200167603                         | 200075572                |                      |                            |
| 1.6mm    | 200167504                   | 200167604                         | 200075572                | 200075514            |                            |
| 1.7mm    | 200167505                   | 200167605                         | 200075573                | 200075515            |                            |
| 1.8mm    | 200167506                   | 200167606                         | 200075578                | 200075516            |                            |
| 1.9mm    | 200167507                   | 200167607                         | 200075578                | 200075516            |                            |
| 2.0mm    | 200167508                   | 200167608                         |                          |                      | 200076615                  |
| 2.1mm    | 200167509                   | 200167609                         |                          |                      | 200076615                  |
| 2.2mm    | 200167510                   | 200167610                         |                          |                      | 200076615                  |
| 2.3mm    | 200167511                   | 200167611                         |                          |                      | 200076618                  |
| 2.4mm    | 200167512                   | 200167612                         |                          |                      | 200076618                  |
| 2.5mm    | 200167513                   | 200167613                         |                          |                      | 200076621                  |
| 2.8mm    | 200167516                   | 200167616                         |                          |                      | 200076630                  |

System Set-up Diagram

**ST167 Specification:**  
 Min - 8lpm, 80 bar  
 Max - 80lpm, 350 bar  
 Inlet - 1/2" F  
 Outlet - 1/2" F

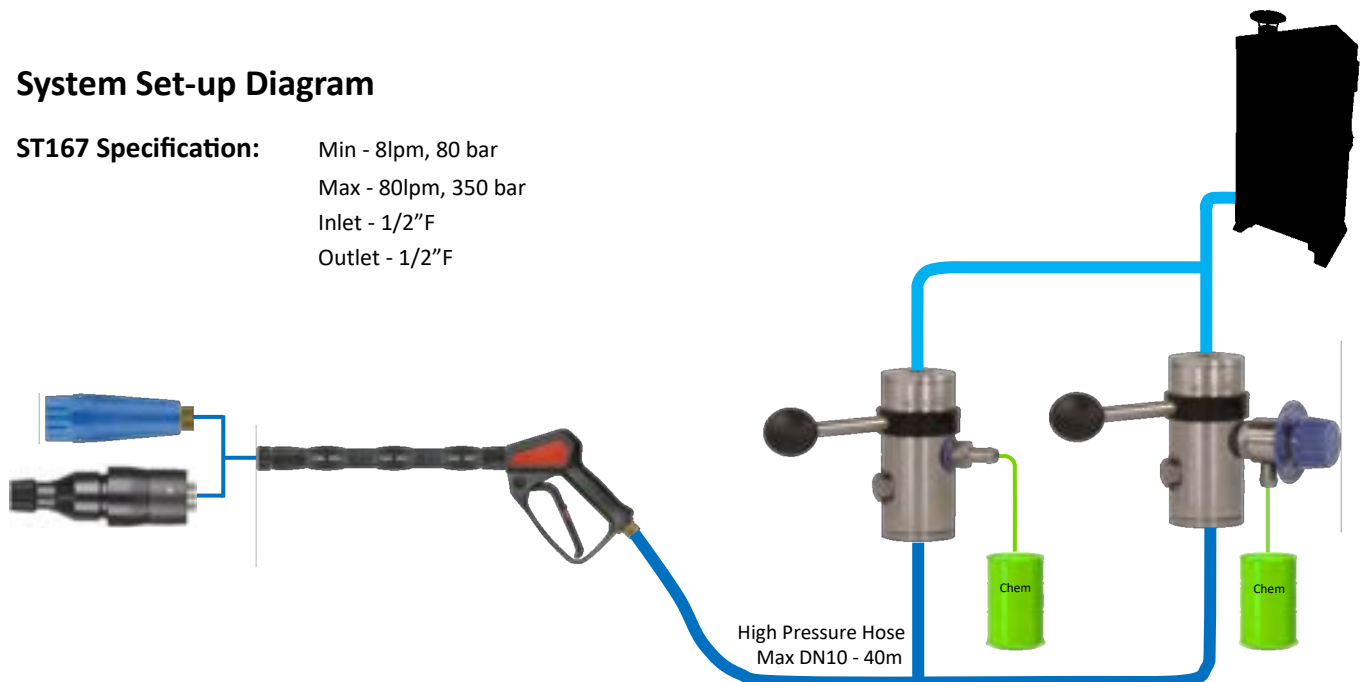

ST168 Full Flow Foam Injectors with Compressed Air



| Jet Size | ST168 + Fixed Metering Tips | ST168 + Adjustable Metering Valve | Suitable Foam Lance | Suitable 3 Function Nozzle: Foam/Disinfect/Rinse |
|----------|-----------------------------|-----------------------------------|---------------------|--|
| Thread   | 1/2" F                      | 1/2" F                            | ST3100 QR Plug      | 1/2" M   |
| 1.3mm    | 200168505                   | 200168601                         | 203100630           | 6576500  |
| 1.4mm    | 200168515                   | 200168602                         |                     |  |
| 1.5mm    | 200168525                   | 200168603                         |                     |  |
| 1.6mm    | 200168535                   | 200168604                         |                     |  |
| 1.7mm    | 200168545                   | 200168613                         |                     |  |
| 1.8mm    | 200168555                   | 200168606                         |                     |  |
| 1.9mm    | 200168605                   | 200168607                         |                     |  |
| 2.0mm    | 200168615                   | 200168608                         |                     |  |
| 2.1mm    | 200168625                   | 200168609                         |                     |  |
| 2.2mm    | 200168635                   | 200168610                         |                     |  |
| 2.3mm    | 200168645                   | 200168611                         |                     |  |
| 2.4mm    | 200168650                   | 200168612                         |                     |  |
| 2.5mm    | 200168655                   | 200168616                         |                     |  |
| 2.8mm    | 200168660                   | 200168617                         |                     |  |



**Mounting Bracket**  
200168420

**System Set-up Diagram**

**ST168 Specification:** Min - 8lpm, 80 bar  
Max - 80lpm, 350 bar  
Inlet - 1/2" F  
Outlet - 1/2" F

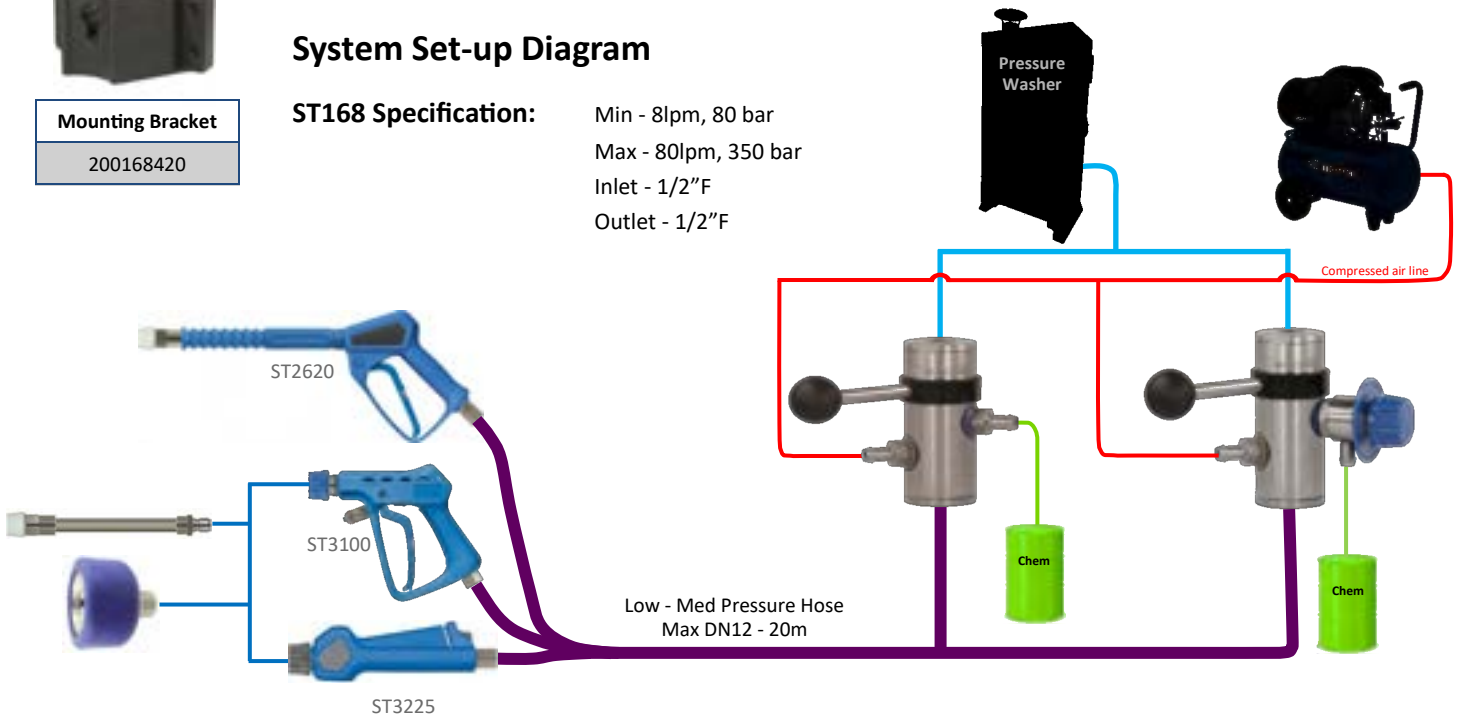

ST160, 164, 167 & 168 Spare Parts



| Injector Nozzle |                         |              | Counter Nozzle |                              |
|-----------------|-------------------------|--------------|----------------|------------------------------|
| ∅ mm            | To Fit ST160, 167 & 168 | To Fit ST164 | ∅ mm           | To Fit ST160, 164, 167 & 168 |
| 1.2             | 040003642               | 040003534    | 1.7            | 040003517                    |
| 1.3             | 040003643               | 040003535    | 1.7            | 040003517                    |
| 1.4             | 040003644               | 040003536    | 2.0            | 040003521                    |
| 1.5             | 040003645               | 040003537    | 2.0            | 040003521                    |
| 1.6             | 040003646               | 040003538    | 2.0            | 040003521                    |
| 1.7             | 040003647               | 040003539    | 2.3            | 040003523                    |
| 1.8             | 040003648               | 040003541    | 2.3            | 040003523                    |
| 1.9             | 040003649               | 040003542    | 2.3            | 040003523                    |
| 2.0             | 040003650               | 040003543    | 2.8            | 040003528                    |
| 2.1             | 040003651               | 040003544    | 2.8            | 040003528                    |
| 2.2             | 040003652               | 040003546    | 2.8            | 040003528                    |
| 2.3             | 040003653               | 040003547    | 2.8            | 040003528                    |
| 2.4             | 040003654               | 040003548    | 2.8            | 040003528                    |
| 2.5             | 040003655               | 040003531    | 3.2            | 040003532                    |
| 2.8             | 040003658               | 040003549    | 3.2            | 040003532                    |

|                                |
|--------------------------------|
| Set of 10 Chemical Dosing Tips |
| 200163340                      |



| Dosing Chart |          |
|--------------|----------|
| Orifice Size | Dosing % |
| 0.5mm        | 0.5%     |
| 0.6mm        | 0.8%     |
| 0.7mm        | 1%       |
| 1.0mm        | 2.5%     |
| 1.1mm        | 3%       |
| 1.2mm        | 4%       |
| 1.3mm        | 5%       |
| 1.5mm        | 8%       |
| 1.7mm        | 10%      |
| 2.0mm        | 13.5%    |

Chemical Metering Valves & Pipe



|                | ST163.1 4 Chemical Metering Valve<br>Fits ST160, 164, 167 & 168 | ST161 Metering Valve<br>Fits ST160, 164, 167 & 168 | ST161 Metering Valve<br>+ EPDM Seals | ST161 Inline |
|----------------|---|--|--------------------------------------|--------------|
| Inlet / Outlet | 4 x 9mm HT x M14M   | 9mm HT x M14M                                      | 9mm HT x M14M                        | 9mm HT       |
| Part No        | 200163185   | 200161500  | 200161515                            | 200161510    |

Injector Connections



| M14M x 9mm HT Check Valve | M14M x 1/4" M Check Valve | M18M x 1/4" M Air Check Valve | M14M Plug for ST167/8 | M18M Plug for ST164 |
|---------------------------|---------------------------|-------------------------------|-----------------------|---------------------|
| 200163350                 | 200163356                 | 200164366                     | 040003625             | 200164345           |

ST72 Stainless Steel Foam Lances



|           |        | ST72 with Vented Grip & Side Handle |           |           |           | ST72.1 with 'No Excess Spray' Body & Side Handle |           |           |           |
|-----------|--------|-------------------------------------|-----------|-----------|-----------|--|-----------|-----------|-----------|
|           | Length | 600                                 | 1200      | 600       | 1200      | 600  | 1200      | 600       | 1200      |
| Inlet     | Ø      | 1/4" M                              | 1/4" M    | QR Spigot | QR Spigot | 1/4" M   | 1/4" M    | QR Spigot | QR Spigot |
| 9-11 lpm  | 2.0mm  | -                                   | -         |           |           | 200072633  | 200072634 | 200072646 | 200072647 |
| 11-15 lpm | 2.3mm  | 200072510                           | 200072610 | 200072512 | 200072612 | 200072625  | 200072626 | 200072648 | 200072649 |
| 15-21 lpm | 3.2mm  | 200072520                           | 200072620 | 200072522 | 200072622 | 200072629  |           | 200072653 |           |

ST75 Foam Lances



| Nozzle Size (Ø) | With Stainless Steel Foam Pad | With Stainless Steel Foam Pad | ST75 Stainless Steel Head |
|-----------------|-------------------------------|-------------------------------|---------------------------|
| 04 - (1.20)     | 200075574                     |                               |                           |
| 05 - (1.35)     | 200075576                     |                               |                           |
| 06 - (1.45)     | 200075577                     |                               |                           |
| 075 - (1.60)    | 200075572                     | 200075552                     | 200075514                 |
| 08 - (1.75)     | 200075575                     | 200075558                     |                           |
| 10 - (1.90)     | 200075573                     | 200075553                     | 200075515                 |
| 13 - (2.10)     | 200075578                     | 200075013                     |                           |
| 15 - (2.30)     | 200075579                     |                               |                           |
| 20 - (2.65)     | 200075581                     |                               |                           |

| ST75.1 With Fabric Foam Mesh |           |
|------------------------------|-----------|
| M18F                         | 1/4" F    |
| 200075482                    | 200075493 |

ST75 Foam Lance Nozzles



| Nozzle Size | 04        | 05        | 06        | 07        | 075       | 08        | 10        | 13        | 15        | 20        |
|-------------|-----------|-----------|-----------|-----------|-----------|-----------|-----------|-----------|-----------|-----------|
| Ø           | 1.2       | 1.35      | 1.45      | 1.55      | 1.6       | 1.7       | 1.9       | 2.1       | 2.3       | 2.65      |
| Part No     | 200075403 | 200075405 | 200075406 | 200075427 | 200075407 | 200075408 | 200075410 | 200075413 | 200075415 | 200075420 |

ST75 Foam Lance Spares



|                                |
|--------------------------------|
| Replacement Stainless Foam Pad |
| GS25151251                     |



|                              |
|------------------------------|
| Replacement Fabric Foam Mesh |
| 020000606                    |

**ST76 Foam Blaster Nozzle**

For applications with a high flow rate, the ST76 is the perfect solution. Designed for use in agriculture, fire fighting & municipal cleaning sectors.  
1/2" F, 20-60lpm, 250bar, 100°C



| ∅         | Nozzles Supplied                                    | Part No   |
|-----------|---|-----------|
| Head Only | -   | 200076400 |
| 2.3mm     | 3 x 05  | 200076615 |
| 2.6mm     | 3 x 06  | 200076618 |
| 2.8mm     | 3 x 07  | 200076621 |
| 2.9mm     | 3 x 075   | 200076600 |
| 3.0mm     | 3 x 08  | 200076624 |
| 3.3mm     | 3 x 10  | 200076630 |
| Use with  | ST160, 164 & 167 2.0mm Injectors and above & 20lpm+ |           |

| ∅   | Replacement Internal Nozzles |
|-----|------------------------------|
| 05  | 200075405                    |
| 06  | 200075406                    |
| 07  | 200075427                    |
| 075 | 200075407                    |
| 08  | 200075408                    |
| 10  | 200075410                    |

**ST175 Twin Foam Lances with 1/4 Twist ST58**



| 650mm          | With ST75 Foam Head  | Without Foam Head    |
|----------------|----------------------|----------------------|
| Rating         | 350bar, 45lpm, 100°C | 350bar, 45lpm, 100°C |
| No ST75 Nozzle | 200175400            | 200175510            |

| Length | With ST75 Foam Head  |
|--------|----------------------|
| Rating | 350bar, 45lpm, 100°C |
| 420mm  | 200175412            |

**Long Cast ST75.2 Foam Nozzle**



| 1/4" F, 150bar, 90°C | Internal Nozzle | Part No   |
|----------------------|-----------------|-----------|
| Flow Rate lpm        | Body Only       | 200075800 |
| 11-12                | 07 (1.55)       | 200075801 |
| 12-14                | 075 (1.6)       | 200075802 |
| 14-17                | 10 (1.9)        | 200075803 |
| 18-20                | 13 (2.1)        | 200075804 |
| 21-22                | 15 (2.3)        | 200075805 |
| 23-27                | 15 (2.3)        | 200075806 |
| 28-30                | 20 (2.65)       | 200075807 |
| 31-40                | 20 (2.65)       | 200075811 |

Easywash 365+ Gun & Foam Lance



LTF

|                | ST2600 + 245mm Ext + ST75 | ST2600 + Freeze Stop Valve + 245mm Ext + ST75 | ST2600 + Freeze Stop Valve + 245mm Ext + ST75 |
|----------------|---------------------------|---|---|
| Rating         | 310bar, 25lpm, 150°C      | 310bar, 25lpm, 150°C                          | 310bar, 25lpm, 150°C                          |
| Foam Jet Size  | 1.9mm (10)                | 1.2mm (04)                                    | 1.9mm (10)                                    |
| Trigger Colour | Orange                    | Blue  | Blue  |
| Part No        | 202600918                 | 202600929                                     | 202600919                                     |

Stainless Steel Foam Guns for use with added Compressed Air



|               |           | ST3225               | ST3225               | ST3100               | ST2725              | ST2720               |
|---------------|-----------|----------------------|----------------------|----------------------|---------------------|----------------------|
| Inlet         | Outlet    | 24bar, 120lpm, 100°C | 60bar, 120lpm, 100°C | 60bar, 100lpm, 150°C | 80bar, 80lpm, 150°C | 125bar, 80lpm, 150°C |
| 1/2" F        | 3/8" F    |                      |                      |                      |                     | 202720530            |
| 1/2" F        | ST3100QRC |                      |                      | 203100820            |                     |                      |
| 1/2" F Swivel | 1/2" F    |                      | 203225545            |                      | 202725535           |                      |
| 1/2" F Swivel | ST3100QRC | 203225650            | 203225550            |                      | 202725550           | 202720550            |

Foam Nozzles for use with Added Compressed Air Systems



|              | Stainless Steel Hand Held Valve |        | Polypropylene Foam Nozzles<br>50°200 | Stainless Lance Complete<br>50°200 |           | TREBLE NOZZLE<br>50°150, 25°15 & 60°30 |
|--------------|---------------------------------|--------|--------------------------------------|------------------------------------|-----------|--|
| Inlet        | 60bar 95°C                      |        | 45bar, 60°C                          | 80bar, 150°C                       |           | 200bar, 90°C                           |
| 1/2" F       | 1/2" F                          | GS7500 |                                      |                                    |           |  |
|              | ST3100 QRC                      | GS7510 |                                      |                                    |           |  |
| 1/2" M       |                                 |        | 203100910                            |                                    |           | 6576500                                |
| ST3100 Probe |                                 |        | 203100920                            | 70mm                               | 502808    |  |
|              |                                 |        |                                      | 300mm                              | 203100630 |  |

**ST166 Twin Foam Injector**



Designed for use where two separate chemicals need to be applied at the same time. The unit comes with two sets of 10 metering tips to allow for precise dosing.  
Inlet 3/8" F, Outlet 3/8" M

| ST166 + 1.3mm Nozzle | ST166 + 1.6mm Nozzle | ST166 + 1.9mm Nozzle |
|----------------------|----------------------|----------------------|
| 350bar, 90°C         | 350bar, 90°C         | 350bar, 90°C         |
| 200166500            | 200166510            | 200166530            |

**Suttner ST60.1 Foam Injectors**



|     | ST60.1 Foam Injector | ST60.1 Injector inc 5m Chem Pipe, ST61A & ST31R Filter | ST60.1 Injector + QRC Set, ST61A & 2m Chem Pipe | ST60.1 Injector + M22M/F, ST61A & 2m Chem Pipe |
|-----|----------------------|--|---|--|
| Ø   | 250bar, 60°C         | 250bar, 60°C   | 250bar, 60°C                                    | 250bar, 60°C                                   |
| 1.6 | 200060700            | ST60C  | 200060750                                       | 200060760                                      |
| 1.8 | 200060710            | ST60C18  |   |  |

**RM300 Adjustable Chemical Injectors**



|                             | RM300 1.8mm | RM300 2.1mm | RM300 2.3mm |
|-----------------------------|-------------|-------------|-------------|
| 3/8" F x 3/8" M             | 5443181     | 5443211     | 5443231     |
| M22F x M22M                 | 54431811    |             |             |
| M22F x M22M + Hose & Filter | 54431814    |             | 54432314    |



**Dema & Other Injectors**



| KEW Injector         | Dema Variable Flow Injector | Dema Plastic Injector | TecPro Injector with Tamper Proof Dosing | Tamper Proof Dosing Plate & Seal for TecPro Injector |         |
|----------------------|-----------------------------|-----------------------|--|--|---------|
| QRC Coupling & Probe | 3/8" F                      | 3/8" M                | 3/8" M                                   | Seal   | TP49900 |
| 6401244              | 203BSE                      | P203CT                | TP49800                                  | 1% Plate   | TP49924 |
|                      |                             |                       |  | 2%   | TP49932 |
|                      |                             |                       |  | 3%   | TP49940 |
|                      |                             |                       |  | 4%   | TP49947 |
|                      |                             |                       |  | 5%   | TP49954 |
|                      |                             |                       |  | 8%   | TP49963 |
|                      |                             |                       |  | 10%  | TP49970 |

Powder Coated Sprayers & Foamers



| Sprayer Tank Size | Part No   |
|-------------------|-----------|
| 24ltr             | 106024500 |
| 50ltr             | 106050500 |



| Foamer Tank Size | Part No   |
|------------------|-----------|
| 24ltr            | 106024550 |
| 50ltr            | 106050550 |

Stainless Steel Sprayers & Foamers



| Sprayer Tank Size | Part No   |
|-------------------|-----------|
| 24ltr             | 106024600 |
| 50ltr             | 106050600 |



| Foamer Tank Size | Part No   |
|------------------|-----------|
| 24ltr            | 106024650 |
| 50ltr            | 106050650 |

Tank Sprayer & Foamer Spares



| Sprayer Hose | Foamer Hose | Gun + 600mm Lance (w/o nozzle) | Foam Head 1/4" M |
|--------------|-------------|--------------------------------|------------------|
| 10691101     | 10690101    | 200510550                      | 1069060          |



| 55°55 Nozzle | 60°25 Nozzle | 110°03 Nozzle | 110°04 Nozzle | 110°045 Nozzle | Nozzle Holder | Nozzle Gasket | Filter Mesh |
|--------------|--------------|---------------|---------------|----------------|---------------|---------------|-------------|
| 60980559     | 60980259     | 60911003      | 60911004      | 609110045      | 1069093       | 1069094       | 1069092     |



# **SITE & VEHICLE WASH EQUIPMENT**

|   |            |
|---|------------|
| <b>TEHA Hose Reels</b>                    | <b>122</b> |
| <b>TEHA Swivel Brackets</b>               | <b>123</b> |
| <b>Ecodora Stainless Steel Reels</b>      | <b>124</b> |
| <b>Stainless Steel Hose Reel Trolleys</b> | <b>125</b> |
| <b>Lance &amp; Brush Holders</b>          | <b>126</b> |
| <b>Vehicle Wash Booms</b>                 | <b>127</b> |
| <b>Coin &amp; Token Meters</b>            | <b>128</b> |
| <b>Marolex Pump Up Sprayers</b>           | <b>129</b> |
| <b>Compression Fittings &amp; Clamps</b>  | <b>130</b> |

# SITE & VEHICLE WASH EQUIPMENT

## Powder Coated Hose Reels by **TEHA**

### Manual Rewind



### Automatic Spring Rewind

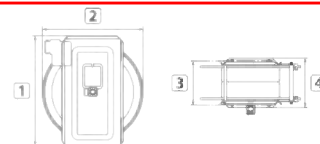

| Model   | 1     | 2     | 3     | 4     | Weight |
|---------|-------|-------|-------|-------|--------|
| 75014   | 440mm | 400mm | 176mm | 206mm | 14kg   |
| 75020   | 500mm | 460mm | 176mm | 206mm | 16kg   |
| 75030   | 500mm | 460mm | 226mm | 256mm | 18kg   |
| 75040   | 500mm | 460mm | 276mm | 306mm | 25kg   |
| 7502019 | 500mm | 460mm | 176mm | 206mm | 17kg   |
| 7504019 | 500mm | 460mm | 376mm | 406mm | 26.5kg |

| Hose Size | Capacity | Inlet/Outlet | Rating       | Part No      |
|-----------|----------|--------------|--------------|--------------|
| DN8       | 24m      | 3/8" F       | 400 bar, 90C | <b>76020</b> |
|           | 32m      | 3/8" F       | 400 bar, 90C | <b>76030</b> |
| DN10      | 19m      | 3/8" F       | 400 bar, 90C | <b>76020</b> |
|           | 28m      | 3/8" F       | 400 bar, 90C | <b>76030</b> |

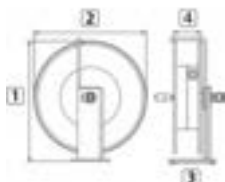

| Model | 1     | 2     | 3     | 4     | Weight |
|-------|-------|-------|-------|-------|--------|
| 76020 | 437mm | 400mm | 210mm | 100mm | 6.2kg  |
| 76030 | 500mm | 460mm | 210mm | 100mm | 6.8kg  |

| Hose Size | Capacity | Inlet/Outlet | Rating       | Part No          |
|-----------|----------|--------------|--------------|------------------|
| DN8       | 14m      | 3/8" F       | 400 bar, 90C | ● <b>75014</b>   |
|           | 20m      | 3/8" F       | 400 bar, 90C | ● <b>75020</b>   |
|           | 30m      | 3/8" F       | 400 bar, 90C | ■ <b>75030</b>   |
|           | 40m      | 3/8" F       | 400 bar, 90C | ■ <b>75040</b>   |
| DN10      | 12m      | 3/8" F       | 400 bar, 90C | ● <b>75014</b>   |
|           | 17m      | 3/8" F       | 400 bar, 90C | ● <b>75020</b>   |
|           | 26m      | 3/8" F       | 400 bar, 90C | ■ <b>75030</b>   |
|           | 35m      | 3/8" F       | 400 bar, 90C | ■ <b>75040</b>   |
| DN19      | 10m      | 3/4" F       | 200 bar, 90C | ● <b>7502019</b> |
|           | 35m      | 3/4" F       | 200 bar, 90C | ▲ <b>7504019</b> |

## Stainless Steel Hose Reels by **TEHA**

### Manual Rewind



### Automatic Spring Rewind



| Model   | 1     | 2     | 3     | 4     | Weight |
|---------|-------|-------|-------|-------|--------|
| 74014   | 440mm | 400mm | 176mm | 206mm | 14kg   |
| 74020   | 500mm | 460mm | 176mm | 206mm | 16kg   |
| 74030   | 500mm | 460mm | 226mm | 256mm | 18kg   |
| 74040   | 500mm | 460mm | 276mm | 306mm | 25kg   |
| 74060   | 500mm | 460mm | 376mm | 406mm | 32.5kg |
| 7402012 | 500mm | 460mm | 176mm | 206mm | 16kg   |
| 7404012 | 500mm | 460mm | 276mm | 306mm | 25kg   |
| 7404019 | 500mm | 460mm | 376mm | 406mm | 26.5kg |

| Hose Size | Capacity | Inlet/Outlet | Rating       | Part No        |
|-----------|----------|--------------|--------------|----------------|
| DN12      | 35m      | 1/2" F       | 300 bar, 90C | ◆ <b>73950</b> |
|           | 70m      | 1/2" F       | 300 bar, 90C | <b>73960</b>   |
|           | 100m     | 1/2" F       | 300 bar, 90C | <b>73965</b>   |
|           | 115m     | 1/2" F       | 300 bar, 90C | <b>7397012</b> |
| DN19      | 40m      | 3/4" F       | 200 bar, 90C | <b>7396019</b> |

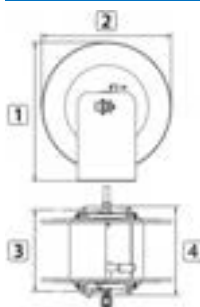

| Model   | 1     | 2     | 3     | 4     | Weight |
|---------|-------|-------|-------|-------|--------|
| 73950   | 515mm | 465mm | 280mm | 312mm | 10.5kg |
| 73960   | 515mm | 465mm | 480mm | 512mm | 13.5kg |
| 73965   | 515mm | 465mm | 680mm | 712mm | 15.7kg |
| 7397012 | 515mm | 465mm | 780mm | 812mm | 16.8kg |
| 7396019 | 515mm | 465mm | 480mm | 512mm | 14.7kg |

| Hose Size | Capacity | Inlet/Outlet | Rating        | Part No          |
|-----------|----------|--------------|---------------|------------------|
| DN8       | 14m      | 3/8" F       | 400 bar, 90C  | ● <b>74014</b>   |
|           | 20m      | 3/8" F       | 400 bar, 90C  | ● <b>74020</b>   |
|           | 30m      | 3/8" F       | 400 bar, 90C  | ■ <b>74030</b>   |
|           | 40m      | 3/8" F       | 400 bar, 90C  | ■ <b>74040</b>   |
|           | 55m      | 3/8" F       | 400 bar, 90C  | ▲ <b>74060</b>   |
| DN10      | 12m      | 3/8" F       | 400 bar, 90C  | ● <b>74014</b>   |
|           | 17m      | 3/8" F       | 400 bar, 90C  | ● <b>74020</b>   |
|           | 26m      | 3/8" F       | 400 bar, 90C  | ■ <b>74030</b>   |
|           | 35m      | 3/8" F       | 400 bar, 90C  | ■ <b>74040</b>   |
| DN12      | 48m      | 3/8" F       | 400 bar, 90C  | ▲ <b>74060</b>   |
|           | 17m      | 1/2" F       | 300 bar, 90°C | ● <b>7402012</b> |
|           | 35m      | 1/2" F       | 300 bar, 90°C | ■ <b>7404012</b> |
| DN19      | 35m      | 3/4" F       | 200 bar, 90C  | ▲ <b>7404019</b> |

## SITE & VEHICLE WASH EQUIPMENT

### TEHA Hose Reel Swivel Brackets



360° Adjustable rotation  
with 16 fixing points



| Stainless Steel Base Swivel for 73950 | 180° Steel Swivel Wall Bracket | 180° 304 Stainless Steel Swivel Wall Bracket | 180° 304 Stainless Steel Wall Back Plate |
|---------------------------------------|--------------------------------|--|--|
| ◆ HCD100819                           | ● 74100                        | ● 74101                                      |  |
|                                       | ■ 741001                       | ■ 741011                                     |  |
|                                       | ▲ 741003                       | ▲ 741012                                     | ▲▲ 741002                                |

### TEHA Hose Guidance System



| Hose Window | Flat Roller Guide | Compact Roller Guide | Elongated Style | Wall Mounted Guide |
|-------------|-------------------|----------------------|-----------------|--------------------|
| 50 x 37mm   | HGF001            | 74106                |                 | V10710056          |
| 158 x 32mm  |                   |                      | TPEFW2          |                    |
| 258 x 32mm  |                   |                      | TPEFW3          |                    |

### Other Hose Reel Accessories



| Size            | Swivel    | Swivel Repair Kit | Hose Stop | Replacement Rollers |             |
|-----------------|-----------|-------------------|-----------|---------------------|-------------|
| 3/8" F x 3/8" M | 200322500 | 200322490         | 74103     | 48 x 18mm           | E1071000621 |
| 1/2" F x 3/8" M | 200322510 | 200322490         |           | 150 x 18mm          | E107100062  |
| 1/2" F x 1/2" M | 200322520 | 200322490         |           |                     |             |
| 3/4" F x 3/4" M | 7504001   | 7504002           |           |                     |             |

## SITE & VEHICLE WASH EQUIPMENT

### Atex Approved Stainless Steel Automatic Rewind Hose Reels with Adjustable Arms



RM434



RM534



RM544

| RM434 | Capacity | 304 Stainless Reel |
|-------|----------|--------------------|
| DN8   | 21m      | 76343430           |
| DN10  | 16m      |                    |
| DN12  | 14m      |                    |
|       | Rating   | 300 bar, 90°C      |
|       | In/Out   | 1/2" F             |

| Hose | Capacity | 304 Stainless Reel |
|------|----------|--------------------|
| DN8  | 30m      | 76353430           |
| DN10 | 26m      |                    |
| DN12 | 24m      |                    |
|      | Rating   | 300 bar, 90°C      |
|      | In/Out   | 1/2" F             |

| Hose | Capacity | In/Out | 304 Stainless Reel |
|------|----------|--------|--------------------|
| DN12 | 30m      | 1/2" F | 76354430           |
| DN19 | 17m      | 1" F   | 76354420           |
|      | Rating   | 1/2"   | 300 bar, 90°C      |
|      | Rating   | 1"     | 100 bar, 90°C      |

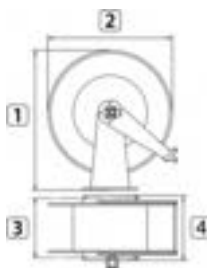

| Pos    | Dims  |
|--------|-------|
| 1      | 460mm |
| 2      | 420mm |
| 3      | 140mm |
| 4      | 186mm |
| Weight | 14kg  |

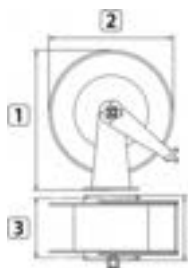

| Pos    | Dims  |
|--------|-------|
| 1      | 560mm |
| 2      | 510mm |
| 3      | 153mm |
| 4      | 203mm |
| Weight | 19kg  |

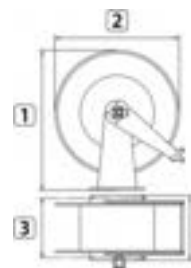

| Pos    | Dims  |
|--------|-------|
| 1      | 573mm |
| 2      | 510mm |
| 3      | 218mm |
| 4      | 300mm |
| Weight | 24kg  |

### ABS & Stainless Automatic Rewind Hose Reels and Accessories

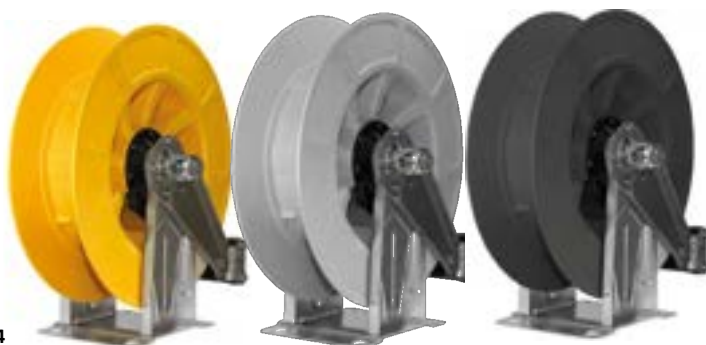

RM434



| Hose | Capacity | Yellow ABS + SS Frame | Grey ABS + SS Frame | Black ABS + SS Frame |
|------|----------|-----------------------|---------------------|----------------------|
| DN8  | 21m      | 76443430              | 76443431            | 76443436             |
| DN10 | 16m      |                       |                     |                      |
| DN12 | 14m      |                       |                     |                      |
|      | Rating   | 300 bar, 90°C         | 300 bar, 90°C       | 300 bar, 90°C        |
|      | In/Out   | 1/2" F                | 1/2" F              | 1/2" F               |

| RM434 Stainless Swivel Bracket | RM534 Stainless Swivel Bracket | RM544 Stainless Swivel Bracket |
|--------------------------------|--------------------------------|--------------------------------|
| 76343006                       | 76353006                       | 76354006                       |

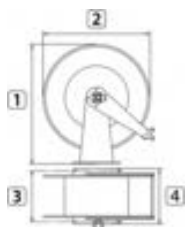

| Pos  | 1     | 2     | 3     | 4     | Weight |
|------|-------|-------|-------|-------|--------|
| Dims | 460mm | 420mm | 140mm | 186mm | 14kg   |



| Inlet Swivel M28M x 1/2" F | 200322523 |
|----------------------------|-----------|
|                            |           |

## SITE & VEHICLE WASH EQUIPMENT

### Stainless Steel Multifunction Trolleys



|                    | Multifunction SS Trolley | Large Multifunction SS Trolley |
|--------------------|--------------------------|--------------------------------|
| Part No            | 710163389                | 200163390                      |
| Dimensions (HxWxD) | 1150 x 540 x 620mm       | 1080 x 680 x 760mm             |

### Stainless Steel Trolleys for Hose Reels



Suitable for Reels:  
73950, 73960, 7395019, 7396019

Suitable for Reels:  
73965, 7396519

|                    | Foldable Hose Reel Trolley with Lance Holders | Large Foldable Hose Reel Trolley with Lance Holders |
|--------------------|---|---|
| Part No            | 712000078                                     | 712000070   |
| Dimensions (HxWxD) | 1210 x 715 x 560mm                            | 1175 x 700 x 650mm                                  |

### Ball Valves



| Thread            | ATEX Approved Stainless Ball Valve | 304 Stainless Steel | Nickel Plated Brass | Zinc Plated Steel | 316 Stainless Steel | Zinc Plated 3-Way (L form) |
|-------------------|------------------------------------|---------------------|---------------------|-------------------|---------------------|----------------------------|
| Rating            | 82bar, 200°C                       | 140bar, 60°C        | 210bar, 80°C        | 500bar, 80°C      | 500bar, 100°C       | 315bar, 60°C               |
| 1/4" F            | LBV14SS                            | 70710               |                     | 70603             | 70715               |                            |
| 3/8" F            | LBV38SS                            | 70720               | 70538382            | 70610*            | 70725*              | 70624                      |
| 1/2" F            | LBV12SS                            | 70730               | 70512122            | 70615*            | 70735*              | 70625                      |
| 3/4" F            | LBV34SS                            | 70740               |                     | 70618 (315 bar)   |                     |                            |
| Mounting Bracket* |                                    |                     |                     | 70800             | 70800               |                            |

## SITE & VEHICLE WASH EQUIPMENT

### Easywash 365+ Stainless Steel Lance & Brush Holders



|                     | Floor Mounted Lance Holder with Drain<br>Wall Bracket available for Wall Mounting | Floor Mounted Lance Holder with Spring and Drain | Raised Floor Mounted Lance Holder with Drain |
|---------------------|---|--|--|
| <b>Part No</b>      | 105620  | 105650   | 105640                                       |
| <b>Dims</b>         | 730 x 60mm  | 730 x 60mm                                       | 730 x 60mm                                   |
| <b>Wall Bracket</b> | 105625  | 105625   |  |



|                | Wall Mounted Lance Holder with Drain | Brush Holder with Overflow & Drain<br>Wall & Floor Mountable | Wall mounted Brush Holder |
|----------------|--------------------------------------|--|---------------------------|
| <b>Part No</b> | 105630                               | 105810   | 10829030                  |
| <b>Dims</b>    | 590 x 60mm                           | 670 x 340 x 143mm  | 90 x 250 x 100mm          |

### Other Carwash Accessories

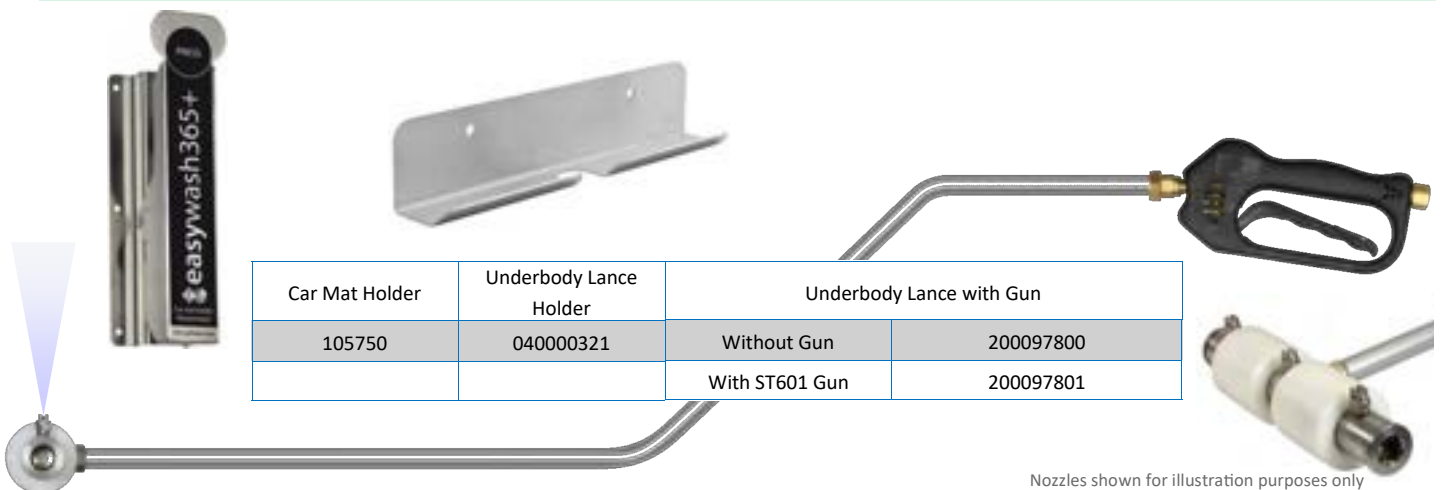

| Car Mat Holder | Underbody Lance Holder | Underbody Lance with Gun |           |
|----------------|------------------------|--------------------------|-----------|
| 105750         | 040000321              | Without Gun              | 200097800 |
|                |                        | With ST601 Gun           | 200097801 |

Nozzles shown for illustration purposes only

## SITE & VEHICLE WASH EQUIPMENT

### Easywash 365+ Car Wash Booms

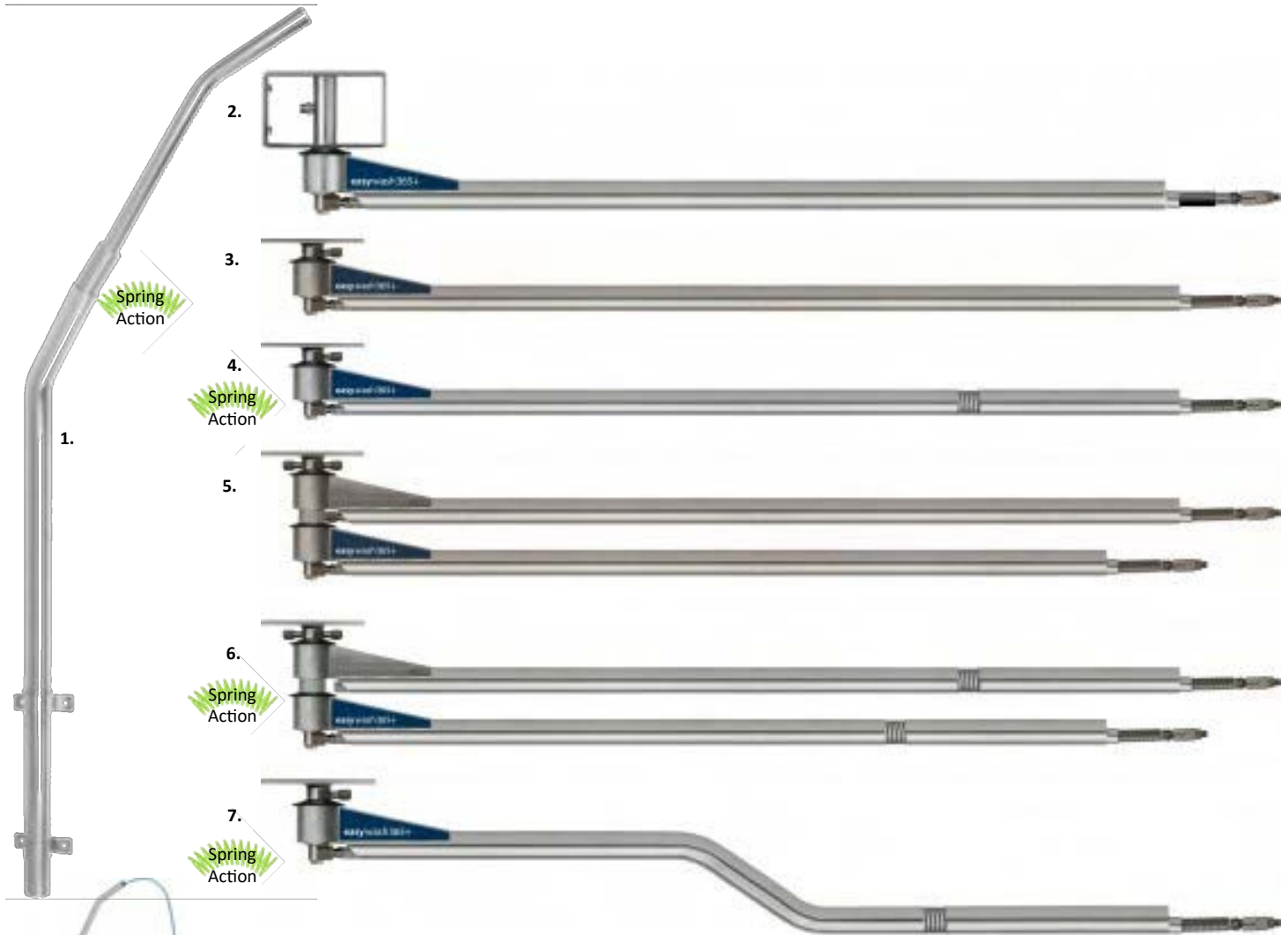

|                 | 1<br>Wall/Cabinet Mounted | 2<br>Wall or Ceiling Mount Boom | 3<br>Ceiling Mount | 4<br>Ceiling Mount Spring Action | 5<br>Twin Boom Ceiling Mount | 6<br>Twin Boom Ceiling Mount Spring Action | 7<br>Z Ceiling Boom Spring Action |
|-----------------|---------------------------|---------------------------------|--------------------|----------------------------------|------------------------------|--|-----------------------------------|
| Height / Length | 2008mm                    | 2500mm                          | 1750mm             | 1750mm                           | 1750 / 1600mm                | 1750 / 1600mm                              | 1550mm                            |
| Inlet/Outlet    | N/A                       | 3/8" M                          | 1/4" F / 1/4" M    | 1/4" F / 1/4" M                  | 1/4" F / 1/4" M              | 1/4" F / 1/4" M                            | 1/4" F / 1/4" M                   |
| Rating          | N/A                       | 275bar, 120°C                   | 275bar, 90°C       | 275bar, 90°C                     | 275bar, 90°C                 | 275bar, 90°C                               | 275bar, 90°C                      |
| Part No         | 10860701                  | 109766973                       | 109766954          | 109766972                        | 109767921                    | 109763904                                  | 109765978                         |

### Wash Boom Accessories



|                |                                |                    |                    |
|----------------|--------------------------------|--------------------|--------------------|
| Mounting Plate | Wall Bracket for Ceiling Booms | Replacement Swivel | Boom Inline Swivel |
| 1097904614     | 109721047                      | 10840926           | 10832927           |
|                |                                | 1/4" M x 3/8" F    | 3/8" F x 1/4" M    |

**Mechanical Coin & Token Meters**

**EMS 81**

The new EMS81 replaces both the old style EMS56 & EMS57's. The new design uses a much simpler programming method, negating the need for the fiddly dip switches of the old design.



New larger mechanism plate size on EMS81's

- Mechanical coin meter with coin /token return
- 1 Style of coin/token accepted
- 3 digit display showing time countdown
- Adjustable time selection from 1-320 minutes per coin/token
- Splash proof electronics
- Powder coated housing

| Payment Type               | 24v        | 230v       |
|----------------------------|------------|------------|
| Token Profiled (no return) | 9281102439 | 9281123039 |
| €1 Euro (with coin return) | 9281102419 | 9281123019 |

**Electronic Coin & Token Meters**

**EMS 82**

The EMS82's are electronic coin testers with built in coin return. Easily programmable and accepts multiple coin (€) denominations.



- Various Euro coins or token accepted
- 3 digit display showing time countdown
- Adjustable time selection for coin value
- Splash proof electronics
- Electronic counter for times, checkouts & clients
- Powder coated housing

| Payment Type | 24v        | 230v       |
|--------------|------------|------------|
| Token & Euro | 9282102409 | 9282123009 |

**Coin/Token Meter Accessories**



| Payment | Mechanism with Microswitch<br>129 x 52mm - EMS56/57 | With Photocell<br>129 x 52mm EMS57/8 | With Photocell<br>150 x 50mm EMS81 | Tokens (bag of 100) |          | Polycarbonate Spray Flap<br>200 x 60 x 30mm<br>10890077 |
|---------|---|--------------------------------------|------------------------------------|---------------------|----------|---|
|         | Token   | 94010                                | 940108                             | 940214              | Profiled |   |
| £1      |   | 94021                                |                                    | 22mm + Hole         | 92915    |   |
| €1      | 94019   | 940198                               | 940211                             | 26mm + Hole         | 92916    |   |
| €2      | 94020   | 940208                               | 940212                             |                     |          |   |



## SITE & VEHICLE WASH EQUIPMENT

### Marolex Pump Up Sprayers



| Mini Line Trigger Spray |           | Ergo Industry |            | Industry Line EPDM Seals |           | Acid Line + Viton Seals |            |
|-------------------------|-----------|---------------|------------|--------------------------|-----------|-------------------------|------------|
| 0.5 ltr                 | 106995005 | 1.5 ltr       | 1069950152 | 7 ltr                    | 106995070 | 7 ltr                   | 1069950701 |
| 1 ltr                   | 106995010 | 2 ltr         | 1069950202 | 9 ltr                    | 106995090 | 9 ltr                   | 1069950901 |
|                         |           |               |            | 12 ltr                   | 106995120 | 12 ltr                  | 1069951201 |

### Marolex Knapsack Sprayers & Pump Up Foamers



**VX ALKA Battery Operated Sprayer**  
 The VX ALKA series have been designed for disinfecting and applying cleaning chemicals.



| Pump Up Sprayer |           |
|-----------------|-----------|
| 12 ltr          | 106995312 |
| 16 ltr          | 106995316 |
| 20 ltr          | 106995320 |

| 12.6v Battery Operated Sprayer |           |
|--------------------------------|-----------|
| 12 ltr                         | 106995612 |

| AXEL pump Up Foamer |           |
|---------------------|-----------|
| 2 ltr               | 106995586 |
| 3 ltr               | 106995587 |

### ST83 Disinfection/Odour Control Fogger



Cold fog air device runs on compressed air, to provide a dry, safe and effective cleaning result. Can be left to run alone, so that the user doesn't inhale any of the solution. 1 litre of chemical can be used to fog a 60m<sup>3</sup> room or 25m<sup>2</sup>

| ST83 Cold Fog Device | Window Bracket for ST83 |
|----------------------|-------------------------|
| 200083500            | 200083400               |



## SITE & VEHICLE WASH EQUIPMENT

### Stainless Steel Pipework & Compression Fittings



| Pipe Size<br>Ø OD |         | Stainless Steel<br>Pipe x 3m | Male Stud Coupling |             | Female Stud<br>Coupling | Straight<br>Connector | 90° Elbow | Tee Connector   | Spare Olives |
|-------------------|---------|------------------------------|--------------------|-------------|-------------------------|-----------------------|-----------|-----------------|--------------|
| 12mm              | Part No | 5991215                      | 599112             |             |                         | 593121                | 594121    | 595121          | 584122       |
|                   | Spec    | 12 x 1.5mm                   | 12L x 3/8"         |             |                         | 12L x 12L             | 12L x 12L | 12L x 12L x 12L |              |
|                   | Rating  | 235 bar                      | 400 bar            |             |                         | 400 bar               | 400 bar   | 400 bar         |              |
| 15mm              | Part No | 5991515                      | 5961538            | 5961512     | 59217                   | 59315                 | 59415     | 59515           | 584152       |
|                   | Spec    | 15 x 1.5mm                   | 15L x 3/8"M        | 15L x 1/2"M | 15L x 3/8"F             | 15L x 15L             | 15L x 15L | 15L x 15L x 15L |              |
|                   | Rating  | 282 bar                      | 400 bar            | 250 bar     | 400 bar                 | 400 bar               | 400 bar   | 400 bar         |              |

### Pipe Clamps & Brackets



|      | Material        | Complete Clamp | Clamp Body<br>(White = W) | Elongated Base<br>Plate | Top Plate | Allen Bolt<br>Use without Top Plate | Hex Bolt<br>For use with Top Plate | M6 Nyloc Nut |
|------|-----------------|----------------|---------------------------|-------------------------|-----------|-------------------------------------|------------------------------------|--------------|
| 12mm | Steel           | SPV12C         | 112APP                    | SPV1A                   | DP1       | IS1 (M6x20)                         | AS1 (M6x30)                        | NNI          |
| 15mm | Steel           | SPV15C         | 215PP                     | SPV2                    | DP2       | IS2 (M6x25)                         | AS2 (M6x35)                        | NNI          |
|      | Stainless/White | SPV15ss        | 215PPW                    | SPV2ss                  | DP2ss     |                                     | AS2ss (M6x35)                      | NNI          |
| 18mm | Steel           | SPV18C         | 218PP                     | SPV2                    | DP2       | IS2 (M6x25)                         | AS2 (M6x35)                        | NNI          |
|      | Stainless/White |                |                           | SPV2ss                  | DP2ss     |                                     | AS2ss (M6x35)                      | NNI          |
| 20mm | Steel           | SPV20C         | 320PP                     | SPV3                    | DP3       | IS3 (M6x30)                         | AS3 (M6x40)                        | NNI          |
|      | Stainless/White |                | 320PPW                    | SPV3ss                  | DP3ss     |                                     | AS3ss (M6x40)                      | NNI          |
| 22mm | Steel           | SPV22C         | 322PP                     | SPV3                    | DP3       | IS3 (M6x30)                         | AS3 (M6x40)                        | NNI          |
|      | Stainless/White | SPV22ss        | 322PPW                    | SPV3ss                  | DP3ss     |                                     | AS3ss (M6x40)                      | NNI          |

### Compression Fitting & Clamp Accessories

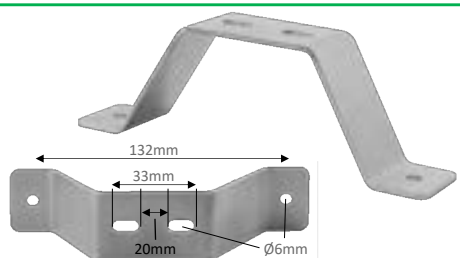

Overall Height = 49.6mm  
Overall Length = 155.9mm



|   |           |  |   |
|---|-----------|--|---|
| <p>Stainless Steel stand off bracket.<br/>To suit size 2 &amp; 3 Stauff clamp bodies<br/>(Replaces SSOB2 &amp; SSOB3)</p> |           | <p>250g Tub of white grease for use on stainless steel couplings to stop them seizing up when screwed together</p> | <p>Dow Corning 7 is a lubricant and preservative compound. Ideal for use with plastics, metals and polymers. The compound is heat stable &amp; resistant to oxidation. 100g tube, Max 200°C</p> |
| Pipe Size   | Part No   | RPASTE50   | GSSRC   |
| 15 - 22mm   | 040003895 |  |   |



## **BURNER EQUIPMENT & SPARES**

|  |            |
|--|------------|
| <b>Replacement Heating Coils</b>         | <b>132</b> |
| <b>Mazzoni Coils &amp; Hotboxes</b>      | <b>133</b> |
| <b>Ignition Electrodes</b>               | <b>134</b> |
| <b>Burner Nozzles &amp; Fuel Filters</b> | <b>135</b> |
| <b>Fuel Pumps</b>                        | <b>136</b> |
| <b>Ignition Transformers</b>             | <b>137</b> |
| <b>Burner Motors &amp; Thermostats</b>   | <b>138</b> |



Karcher Equivalent Heating Coils

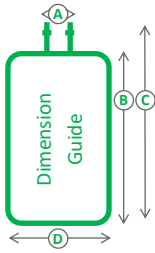

| Part No | KARHC02   | KARHC03   | 200080123  | KARHC04  |
|---------|---|---|--|--|
| Fits    | HDS550c, 501c, 555c, 557ci, 590c, 600c, 601c (240v), 697ci, 698c, 790c, 797ci, 801b | HDS580, 610, 650, 690, 745(old), 750, 755(old), 800b, 800be, 810, 890, 900, 990, 1000be, 1000de, 1200de | 650-4M, 655, 695, 698, 699, 745, 755, 795, 798, 8/18-4, 845-4, 850-4, 895, 9/18-4M, 995, Super | HDS655, 695, 699, 745, 755, 795, 891ST, 895, 945, 995, Super, HDS10/20 |
| A       | 60mm  | 60mm  | 60mm   | 60mm   |
| B       | 310mm   | 360mm   | 390mm  | 390mm  |
| C       | 400mm   | 455mm   | 480mm  | 510mm  |
| D       | 277mm   | 277mm   | 277  | 277mm  |
| Coils   | 14 x 17mm   | 17 x 17mm   | 19 x 17mm  | 19 x 17mm  |
| Weight  | 18kg  | 24kg  | 28kg   | 28kg   |

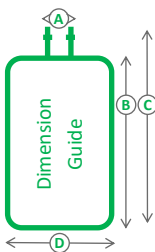

| Part No | KARHC05   | KARHC06   | KARHC07     | KARHC08   | KARHC11  |
|---------|---|---|-------------|-----------|--|
| Fits    | HDS1210, 1250, 1290, 1390, 1000, 1195, 1295ST, 891ST, 1150-4s | HD5/12s, 6/10c, 6/12c, 6/14c, 551c, 558c, 580c, New 601c, 698c, 798c, 990, 1000DE, 1200DE | 10/20-4M/SX | 12/18-4s  | 7/10, 7/11, 7/12-4M, 7/16C, 7/16-4C, 8/17-4M, 9/14, 9/15, 9-17-4M, 9/18-4M, 12/14, 695, 895, 995, 1020 |
| A       | 170mm   | 60mm  | 55mm        | 175mm     | 60mm   |
| B       | 420mm   | 350mm   | 490mm       | 450mm     | 430mm  |
| C       | 530mm   | 435mm   | 580mm       | 560mm     | 540mm  |
| D       | 320mm   | 277mm   | 277mm       | 320mm     | 277mm  |
| Coils   | 17 x 20mm   | 17 x 17mm   | 24 x 17mm   | 22 x 17mm | 21 x 17mm  |
| Weight  | 35kg  | 24.5kg  | 34kg        | 37kg*     | 30kg   |

Other Heating Coils

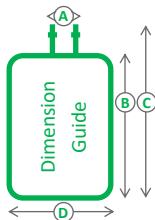

| Part No | MAZHC15       | MAZHC25       | MAZHC30       | PORHC01               | SIRHC01          | SIRHC02       |
|---------|---------------|---------------|---------------|-----------------------|------------------|---------------|
| Fits    | 15lpm Mazzoni | 25lpm Mazzoni | 30lpm Mazzoni | Portotechnica Mistral | Sirio Match Ball | Sirio Skipper |
| A       | 80mm          | 80mm          | 215mm         | 250mm                 | 215mm            | 215mm         |
| B       | 300mm         | 445mm         | 560mm         | 370mm                 | 370mm            | 440mm         |
| C       | 340mm         | 535mm         | 665mm         | 480mm                 | 460mm            | 550mm         |
| D       | 395mm         | 285mm         | 315mm         | 300mm                 | 280mm            | 280mm         |
| Coils   | 15 x 17mm     | 23 x 17mm     | 24 x 21mm     | 19 x 17mm             | 18 x 17mm        | 22 x 17mm     |
| Weight  | 22kg          | 34kg          | 46kg*         | 31kg                  | 28kg             | 32kg          |

\* = despatched on a pallet, due to the weight

**Mazzoni Boilers**



|                   | 15ltr - 200 bar Boiler | 25ltr - 250 bar Boiler | 30ltr - 350 bar |
|-------------------|------------------------|------------------------|-----------------|
| <b>Output</b>     | 46000 Kcal/hr          | 90000 Kcal/hr          | 110000 Kcal/hr  |
| <b>12v</b>        | MAZ120                 | MAZ220                 | MAZ320          |
| <b>240v</b>       | MAZ100                 | MAZ200                 | MAZ300          |
| <b>Spares</b>     |                        |                        |                 |
| <b>Electrodes</b> | MAZ104                 | MAZ104                 | MAZ104          |
| <b>Coil</b>       | MAZHC15                | MAZHC25                | MAZHC30         |

**Mazzoni Fireboxes**



The Mazzoni Hotbox is a great product for converting cold water to hot when more effective cleaning is required. The unit is electrically powered and diesel heated. The Mazzoni firebox has the ability to heat cold water up to 150 °C. All units have a stainless steel cover on a powder coated steel frame. The unit gives high performance with low fuel consumption and has a control panel with switch and thermostat to regulate the temperature. It also features flame control, flow switch, level switch, LED alarm, safety valve and hours counter display.

|             | 15ltr, 250 bar | 20ltr, 250 bar | 25ltr 250 bar |
|-------------|----------------|----------------|---------------|
| <b>12v</b>  | MAZ013         | MAZ012         | MAZ020        |
| <b>230v</b> | MAZ021         | MAZ014         | MAZ019        |

**Mazzoni Spares**



| Magic Eye Kit | Electrodes | 12v Ign Transformer w/o cable | Mazzoni HT Lead |
|---------------|------------|-------------------------------|-----------------|
| MAZ421        | MAZ104     | MAZ125                        | MAZ424          |
|               |            | Power Cable                   | MAZ408          |

Electrodes

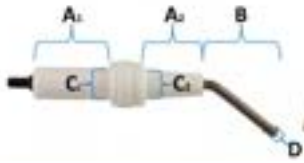

| Dimension Key |                     | ALTO  | COMET    | FIAP/SIAL |
|---------------|---------------------|-------|----------|-----------|
| Part No       |                     | 85060 | COMEL002 | FIAPEL002 |
| A             | Ceramic Length (mm) | 64    | 42       | 30.5/25.5 |
| B             | Probe Length (mm)   | 8     | 34       | 30        |
| C             | Ceramic Width (mm)  | 18    | 9.3      | 10.8/8.8  |
| D             | Probe Width (mm)    | 1.7   | 3        | 3         |



|         | IDROMATIC | IDROMATIC | KARCHER | KARCHER |
|---------|-----------|-----------|---------|---------|
| Part No | GS85160   | 85165     | 85210   | 85212   |
| A       | 40        | 43        | 65      | 37      |
| B       |           |           | 42      | 39      |
| C       | 9         | 9         | 18/8    | 9.8     |
| D       | 1.7       | 1.7       | 3.5     | 1.9     |



|         | KRANZLE | LAVORWASH | LAVORWASH | MAZZONI |
|---------|---------|-----------|-----------|---------|
| Part No | 1244080 | LAV002    | LAV003    | MAZ104  |
| A       | 130     | 22.5/18   | 50        | 60      |
| B       | 40      | 35        | 48        | 45      |
| C       | 6.4     | 11        | 7.5       | 9.4     |
| D       | 1.6     | 3         | 2         | 3       |



|         | PORTOTECNICA | SIRIO     | TEHA      | TEHA      |
|---------|--------------|-----------|-----------|-----------|
| Part No | 85100        | SIREL001  | E10400462 | E10400053 |
| A       | 56           | 28/30     | 55        | 55        |
| B       | 42           | 34        | 40        | 32        |
| C       | 9.4          | 12.8/10.7 | 10.9      | 11.2      |
| D       | 3            | 3         | 2.7       | 2.7       |

Burner Nozzles



9/16 UNF x 1/4" F Burner Nozzle Adaptor

GSBNA

Danfoss Fuel Nozzles

| Size | Angle | Solid (S) | Half Hollow (B) | Hollow (H) |
|------|-------|-----------|-----------------|------------|
| 0.50 | 60°   | 67490     |                 |            |
|      | 80°   | 67740     |                 |            |
| 0.65 | 60°   | 67500     |                 | GS06560H   |
| 0.75 | 45°   |           |                 | GS07545H   |
|      | 60°   | 67510     |                 | 67511      |
| 0.85 | 45°   | GS08545S  |                 |            |
|      | 60°   | 67520     |                 | 67521      |
|      | 80°   | 67770     |                 | 67771      |
| 1.00 | 45°   |           |                 | GS10045H   |
|      | 60°   | 67530     | 67532           | 67531      |
|      | 80°   | 67780     |                 | 67781      |
| 1.10 | 45°   | GS11045S  |                 | GS11045H   |
|      | 60°   | 67535     |                 | 67536      |
| 1.25 | 45°   | GS12545S  |                 | GS12545H   |
|      | 60°   | 67540     |                 | 67541      |
|      | 80°   | 67790     |                 | 67791      |
| 1.35 | 45°   | GS13545S  |                 |            |
|      | 60°   | 67550     | 67552           | 67551      |
| 1.5  | 45°   | GS15045S  |                 | GS15045H   |
|      | 60°   | 67560     |                 | 67561      |
| 1.65 | 60°   | GS16560S  |                 |            |
| 1.75 | 60°   | 67570     |                 | 67571      |
| 2.00 | 60°   | 67580     |                 | 67581      |
|      | 80°   | 67830     |                 |            |
| 2.25 | 45°   |           |                 | GS22545H   |
|      | 60°   |           | MAZ205          | 67591      |
| 2.50 | 60°   |           |                 | 67601      |
| 2.75 | 60°   | 67605     |                 |            |
| 3.00 | 60°   | 67615     |                 | GS30060H   |



Burner Nozzle Cross Reference Chart

| Make    | Solid  | Half Hollow | Hollow |
|---------|--------|-------------|--------|
| Danfoss | S      | B           | H      |
| Delavan | B      | W           | A      |
| Steinen | S/ST   | Q           | H      |
| Monarch | AR/R   | PLS/PLP     | NS/PL  |
| Hago    | ES/B/P | SS          | H      |



Inline Fuel Filters

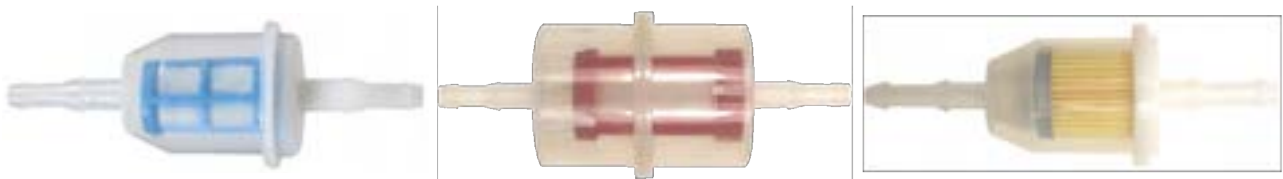

| Part No  | 82905                      | TPFF300                    | TP43PFF                 |
|----------|----------------------------|----------------------------|-------------------------|
| Hosetail | 6-8mm                      | 6-8mm                      | 6mm                     |
| Rating   | 150 micron plastic element | 300 micron plastic element | 43 micron paper element |

Danfoss Fuel Pumps



| Voltage | BFP21 L3<br>Anti-Clockwise Rotation | BFP21 R3<br>Clockwise Rotation | Replacement<br>Coil | Cartridge Filter |
|---------|-------------------------------------|--------------------------------|---------------------|------------------|
| 24v     | 82545                               | 82535                          | 82600 (blue)        | 82500            |
| 240v    | 82540                               | 82530                          | 82610 (black)       | 82500            |

Delta Fuel Pumps



| Voltage | Universal Fuel Pump | Aluminium Fuel Pumps | Replacement<br>Coil | Replacement<br>Gasket |
|---------|---------------------|----------------------|---------------------|-----------------------|
| 24v     | GS037               | 82431                | GS037C              | GS36                  |
| 240v    | GS036               | 82430                | GS036C              | GS36                  |

SP Fuel Pumps



| Voltage | Double Line Intake<br>6-14 bar | Double Line Intake<br>6-14 bar | Replacement<br>Coil | Cartridge Filter |
|---------|--------------------------------|--------------------------------|---------------------|------------------|
| 24v     | 82110                          | 82130                          | 821024              | 82250            |
| 240v    | 82120                          |                                | 821220              | 82250            |

Suntec VM Fuel Pumps

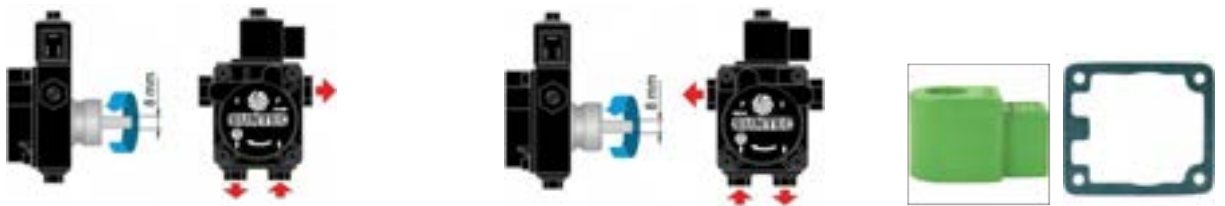

| Voltage | AS47C 1538<br>Adjustable 7-14 bar | AS47D 1539<br>Adjustable 7-14 bar | Replacement<br>Coil | Replacement<br>Gasket |
|---------|-----------------------------------|-----------------------------------|---------------------|-----------------------|
| 24v     | 82700                             |                                   | 82790               | 827992                |
| 240v    | 82710                             | 82715                             | 82795               | 827993                |

Taisan Fuel Pumps



| Electric Fuel Pump |         |
|--------------------|---------|
| 110v               | 4003000 |
| 240v               | 4001002 |

Fuel Pump Spares

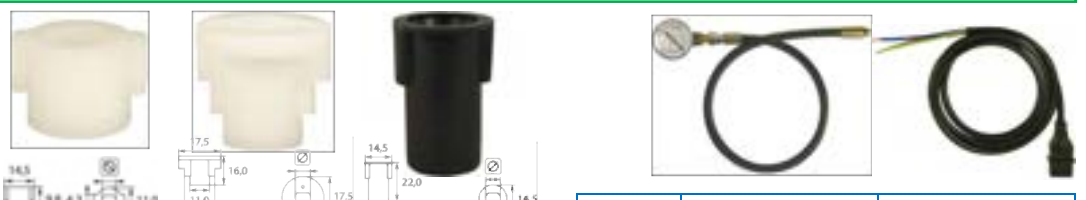

| 6mm Small Drive<br>Peg | 8mm Short Drive<br>Peg | 8mm Long Drive<br>Peg |
|------------------------|------------------------|-----------------------|
| 82230                  | 82225                  | 82235                 |

|        | 0-16bar Gauge &<br>500mm Hose | 1050mm Power Lead<br>to Solenoid - 3 pin |
|--------|-------------------------------|--|
| 500mm  | 5471050                       |  |
| 1000mm |                               | 83240                                    |



Cofi Ignition Transformers



| Model      | Cofi TRS812C | Cofi TRS818C/13 | Cofi TRG1020C |          | Cofi TRK1 |
|------------|--------------|-----------------|---------------|----------|-----------|
| Voltage    | 230v         | 230v            | 230v          | 400v     | 230v      |
| Screw      | 80500        | GS3400818       | 80540         |          |           |
| Ø4mm Push  | GSTRS812CT   |                 | TPITK240      | TPITK400 | SCETRA30  |
| Kv         | 2 x 4Kv      | 11              | 2 x 5Kv       | 2 x 5Kv  | 2 x 12Kv  |
| mA         | 12           | 18              | 20            | 20       | 30        |
| Cable      | 350mm        | 380mm           | 500mm         | 500mm    | 300mm     |
| Spare Lead | GSTP         |                 |               |          | MAZ408    |

Other Ignition Transformers



| Model      | Cofi TRL12-30C | Fida Compact 10/20-100 | May & Christie Z10 100E-1 | Scaldalai 2815 |
|------------|----------------|------------------------|---------------------------|----------------|
| Voltage    | 12v            | 230v                   | 230v                      | 230v           |
| Screw      |                |                        | 80020                     | SCTRA18        |
| Ø4mm Push  | MAZ125         | E10400014              |                           |                |
| Kv         | 2 x 7.5kV      | 2 x 5Kv                | 2 x 5Kv                   | 2 x 4Kv        |
| mA         | 30             | 20                     | 10                        | 18             |
| Cable      |                |                        | 400mm                     | 300mm          |
| Spare Lead | MAZ408         | GSTP                   |                           |                |

Ignition Transformer Leads, Cables & Connectors



| 950mm Single Lead with 6.3 x 4mm crimped Push On Ends | 750mm Single Lead with 4mm Push Connector | 750mm Single Lead with Connector to fit Cofi TRS812 | 450mm Single Kevlar Lead with 4mm Connector | Twin Karcher Style Cable for Twin Electrodes (85212) |
|---|---|---|---|--|
| BUR0010   | GS3409010                                 | MAZ424  | BUR0030                                     | 2702050  |



| Red Ignition Cable |       |             |       | Black Ignition Cable |       |             |       |
|--------------------|-------|-------------|-------|----------------------|-------|-------------|-------|
| Loose/m            | 85540 | 180mm + End | 85520 | Loose/m              | 85550 | 180mm + End | 85515 |



4mm Push On End Piece  
GS3400004



Blue Rubber 90° Connector  
85230

Burner Motors & Flanges

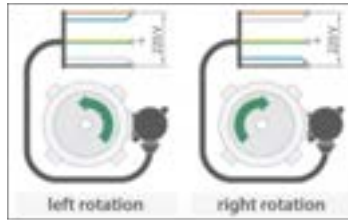

|   |       |
|---|-------|
| <b>240v Burner Motor w/o Flange<br/>200w, 2800rpm, 32mm Hub</b> |       |
| Part No   | 81103 |

|         |                     |                 |
|---------|---------------------|-----------------|
|         | Left/Anti Clockwise | Right/Clockwise |
| Live    | Brown & Blue        | Brown & White   |
| Neutral | Black & White       | Black & Blue    |
| Earth   | Yellow & Green      | Yellow & Green  |

|                      |                      |
|----------------------|----------------------|
| <b>NEMA 1 Flange</b> | <b>NEMA 2 Flange</b> |
| Ø172mm               | Ø184mm               |
| 81101                | 81102                |

Remote Thermostats



|                     |                        |                       |                     |                     |             |             |             |
|---------------------|------------------------|-----------------------|---------------------|---------------------|-------------|-------------|-------------|
|                     | <b>Prodigy TR/711N</b> | <b>Prodigy TR/741</b> | <b>Emerson 1536</b> | <b>Emerson 8654</b> | <b>Koch</b> | <b>Koch</b> | <b>Koch</b> |
| <b>Part No</b>      | TPTHE120               | TPTHE150              | 91016               | 91015               | 91013       | 91012       | 91010       |
| <b>Temp Range</b>   | 30-150°C               | 30-150°C              | 0-160°C             | 30-150°C            | 0-152°C     | 30-150°C    | 30-150°C    |
| <b>Nut Thread</b>   | M14M                   | M14M                  | M14M                | 3/8" M              | 3/8" M      | 3/8" M      | 3/8" M      |
| <b>Coil Length</b>  | 1200mm                 | 1500mm                | 1550mm              | 1550mm              | 920mm       | 1520mm      | 1450mm      |
| <b>Probe Length</b> | 90mm                   | 90mm                  | 50mm                | 48mm                | 44.5mm      | 44.5mm      | 38mm        |
| <b>Contact</b>      | 16A - 400v             | 16A - 400v            | 16A - 380v          | 16A - 380v          | 16A - 380v  | 16A - 380v  | 16A - 250v  |

Thermostat and Burner Accessories



|                |                           |                       |                |             |             |                      |                           |
|----------------|---------------------------|-----------------------|----------------|-------------|-------------|----------------------|---------------------------|
|                | <b>Thermostat Housing</b> | <b>Inline Housing</b> | <b>Adaptor</b> | <b>Dial</b> | <b>Ring</b> | <b>Inlet Adaptor</b> | <b>Remote Thermometer</b> |
| <b>Part No</b> | TPTH9565                  | TPTH1238              | TPTN1214       | TPTK02      | TPTR01      | GS6200558            | 91020                     |
| <b>Info</b>    | 1/2" M x 65mm             | 1/2" F - 2 x 3/8" F   | M14F x 1/2" M  | 30-150°C    |             | 1/4" M x 12L         | 0-80°C - 1000mm           |

Fuel Solenoid Valves & Flame Control



|               |        |                        |  |
|---------------|--------|------------------------|--|
|               |        | <b>RAPA BV01 Valve</b> | <b>Sirai Valve with Stainless Seat</b> |
| <b>Rating</b> |        | 24bar, 60°C            | Ø2.3mm, 20bar, 130°C                   |
| <b>24v</b>    | 1/8" F | 83010                  | GSCSV24                                |
| <b>230v</b>   | 1/8" F | 83020                  |  |
| <b>230v</b>   | 1/4" F | 83040                  |  |

|                                |                            |   |
|--------------------------------|----------------------------|---|
| <b>Landis &amp; Gyr Relay</b>  | <b>12 Connection Socle</b> | <b>Photocell, Flange &amp; Tension Ring</b> |
| 84225                          | 84018                      | Photocell - 84019                           |
| 220v, safety time 10sec, LAO24 |                            | Flange - 84021                              |
|                                |                            | Tension Ring - 84022                        |

A close-up photograph of a vacuum cleaner nozzle and a circular floor tool on a carpeted floor. The nozzle is white and blue, and the floor tool is white. The background is a light-colored carpet.







## **VAC SPARES & ACCESSORIES**

|   |            |
|---|------------|
| <b>Vacuum Motors</b>                      | <b>140</b> |
| <b>Vacuum Hose &amp; Connectors</b>       | <b>141</b> |
| <b>Vacuum Crevice Tools &amp; Brushes</b> | <b>142</b> |
| <b>Floor Tools &amp; Antistatic</b>       | <b>143</b> |
| <b>Vac Boom &amp; Car Wash</b>            | <b>144</b> |

# VACUUM CLEANER SPARES AND ACCESSORIES

## Vacuum Motors



| Voltage        | Wattage   | Two Stage Through Flow  | Two Stage Bypass  | Two Stage Bypass   | Two Stage Bypass  | Two Stage Tangental   |
|----------------|---|---|---|--|---|---|
| 24v            | 360W  |   |   |  |   | GSMTR226  |
| 110v           | 1000W   |   |   |  | GSMTR159  |   |
| 240v           | 1000W   | GSMTR263  |   |  | GSMTR201  |   |
| 240v           | 1200W   |   | GSMTR145  | GSMTR274   |   |   |
| Carbon Brushes |  |   | GSCAR104  | GSCAR104   |   |   |
| Dimensions     |   |  |  |  |  |  |



| Type           | 064200001      | 063700003      | 402-6          | 061200219      | 069103006      |
|----------------|----------------|----------------|----------------|----------------|----------------|
| Part No        | 262120701      | 262120703      | 262120104      | 262110101      | 262050230      |
| Voltage        | 230v           | 230v           | 230v           | 230v           | 24v            |
| Wattage        | 1200           | 1200           | 1200           | 1100           | 500            |
| H x T x Ø (mm) | 131 x 45 x 127 | 136 x 46 x 143 | 128 x 42 x 134 | 133 x 49 x 148 | 171 x 68 x 144 |



| Type           | BDS 10302      | BDS 12382      | 7778-5         | Universal      | 116136-00      |
|----------------|----------------|----------------|----------------|----------------|----------------|
| Part No        | 262100202      | 262120602      | 262120102      | 262120902      | 262160103      |
| Voltage        | 230v           | 230v           | 230v           | 230v           | 230v           |
| Wattage        | 1000           | 1200           | 1200           | 1200           | 1600           |
| H x T x Ø      | 167 x 70 x 144 | 176 x 70 x 144 | 178 x 72 x 144 | 172 x 66 x 148 | 198 x 87 x 183 |
| Carbon Brushes |                |                |                |                | 262160103B     |

## VACUUM CLEANER SPARES AND ACCESSORIES

### Vac Hose



| ∅ ID | ∅ OD | Key                                   | Black<br>20m coil | Black Antistatic<br>10 <sup>6</sup> Ω/m x 30m coil | Grey<br>20m coil | Silver<br>20m coil | EVA Silver/Blue<br>30m coil |
|------|------|---------------------------------------|-------------------|--|------------------|--------------------|-----------------------------|
| 32mm | 40mm | <span style="color: green;">■</span>  | 26364820          | 26364630   |                  | 26324920           |                             |
| 36mm | 44mm | <span style="color: blue;">■</span>   | 26354820          | -  |                  | 26364920           |                             |
| 38mm | 48mm | <span style="color: red;">■</span>    | 26404820          | 26404630   | 26404520         | 26404920           | 26406030                    |
| 50mm | 61mm | <span style="color: orange;">■</span> | 26504820          | 26504630   | 26504520         | 26504920           |                             |

### Tank to Hose Sleeves



| Size      | 32mm                                 | 38mm                               | 38mm                               | 38mm                               | 38mm                               |
|-----------|--------------------------------------|------------------------------------|------------------------------------|------------------------------------|------------------------------------|
| Fits Hose | <span style="color: green;">■</span> | <span style="color: red;">■</span> | <span style="color: red;">■</span> | <span style="color: red;">■</span> | <span style="color: red;">■</span> |
| ∅         | 49mm                                 | 49mm                               | 49mm                               | 58mm                               | 60mm                               |
| Part No   | 263655                               | 264054                             | 264055                             | 265053                             | GSNUM73A                           |

### Hose to Tool Sleeves



| Size           | PVC 32mm                             |                                      |                                       | PVC 38mm                             |                                       | Rubber<br>38mm   | PVC 50mm                              | Rubber<br>50mm   | Angled Handle                        |                                      |
|----------------|--------------------------------------|--------------------------------------|---------------------------------------|--------------------------------------|---------------------------------------|--|---------------------------------------|--|--------------------------------------|--------------------------------------|
|                | 32mm                                 | 36mm                                 | 58mm                                  | 45mm                                 | 58mm                                  | 38-45mm  | 58mm                                  | 50-58mm  | 32mm                                 | 38mm                                 |
| Part No        | 263250                               | 263650                               | 263658                                | 264052                               | 264050                                | 264051   | 265050                                | 265051   | 263653                               | 264053                               |
| Outlet ∅       | 32mm                                 | 36mm                                 | 58mm                                  | 45mm                                 | 58mm                                  | 38-45mm  | 58mm                                  | 50-58mm  | 35mm                                 | 45mm                                 |
| Fits Hose      | <span style="color: green;">■</span> | <span style="color: green;">■</span> | <span style="color: green;">■</span>  | <span style="color: red;">■</span>   | <span style="color: red;">■</span>    | <span style="color: red;">■</span>   | <span style="color: orange;">■</span> | <span style="color: orange;">■</span>                                    | <span style="color: green;">■</span> | <span style="color: red;">■</span>   |
| Fits Tube/Tool | <span style="color: cyan;">○</span>  | <span style="color: blue;">○</span>  | <span style="color: purple;">○</span> | <span style="color: black;">○</span> | <span style="color: purple;">○</span> | <span style="color: orange;">○</span> <span style="color: black;">○</span> | <span style="color: purple;">○</span> | <span style="color: red;">○</span> <span style="color: purple;">○</span> | <span style="color: blue;">○</span>  | <span style="color: black;">○</span> |

### Vac Tubes

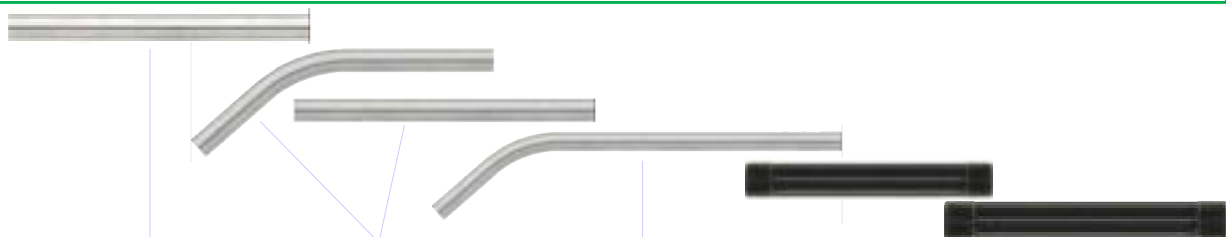

| ∅                | Straight Chrome Plated              | 2 Piece Chrome Plated                 | Angled Chrome Plated               | 45mm Straight PVC                    | 58mm Straight PVC                     |
|------------------|-------------------------------------|---------------------------------------|------------------------------------|--------------------------------------|---------------------------------------|
| Length           | 480mm                               | 1200mm                                | 1200mm                             | 500mm                                | 500mm                                 |
| Fits Tool Sleeve | <span style="color: blue;">○</span> | <span style="color: orange;">○</span> | <span style="color: red;">○</span> | <span style="color: black;">○</span> | <span style="color: purple;">○</span> |
| 35mm             | 263623                              |                                       |                                    |                                      |                                       |
| 38mm             |                                     | 264021                                |                                    | 264023                               |                                       |
| 50mm             |                                     |                                       | 265021                             |                                      | 265023                                |

# VACUUM CLEANER SPARES AND ACCESSORIES

## Crevice Tools



equipped with bars in the mouthpiece



| ∅                | 32mm     |        | 36mm   |         |         | 45mm   |         |         |
|------------------|----------|--------|--------|---------|---------|--------|---------|---------|
| Part No          | GSTLS172 | 263219 | 263619 | 2636191 | 2636192 | 264019 | 2640193 | 2640194 |
| Length           | 630mm    | 200mm  | 200mm  | 300mm   | 370mm   | 245mm  | 350mm   | 350mm   |
| Fits Tube/Sleeve | ○        | ○      | ●      | ●       | ●       | ○      | ○       | ○       |

## Crevice Tools



Screws directly onto the hose

| ∅                | 58mm   |        |        | ∅         | 38mm    | 50mm    |
|------------------|--------|--------|--------|-----------|---------|---------|
| Part No          | 265018 | 265019 | 265020 | Part No   | 2640191 | 2650191 |
| Length           | 270mm  | 230mm  | 370mm  | Length    | 420mm   | 420mm   |
| Fits Tube/Sleeve | ○      | ○      | ○      | Fits Hose | ■       | ■       |

## Vac Brushes



| ∅                | 32mm    | 36mm   |         |         |         |        | 45mm   | 58mm   |        |
|------------------|---------|--------|---------|---------|---------|--------|--------|--------|--------|
| Part No          | GSTLS89 | 263615 | 2636151 | 2636171 | 2636181 | 263620 | 263617 | 264017 | 265017 |
| Width/Length     | ∅ 65mm  | 100mm  | 90mm    | 220mm   | 230mm   | 140mm  | ∅68mm  | ∅70mm  | ∅70mm  |
| Fits Tube/Sleeve | ○       | ●      | ●       | ●       | ●       | ▽      | ●      | ○      | ○      |

## Other Vac Tools



| ∅                | 58mm Coarse Dirt Nozzle | 45mm x 35/36mm Plastic Reducer | 58mm x 35/36mm Plastic Reducer |
|------------------|-------------------------|--------------------------------|--------------------------------|
| Part No          | 265016                  | 264025                         | 265025                         |
| Width/Length     | 120 x 160mm             |                                |                                |
| Fits Tube/Sleeve | ○                       | ○ → ●                          | ○ → ●                          |

## VACUUM CLEANER SPARES AND ACCESSORIES

### Floor Tools



|             |        |         |          |         |
|-------------|--------|---------|----------|---------|
| ∅           | 32mm   | 38mm    | 38mm     | 50mm    |
| Application | Dry    | Wet/Dry | Dry      | Wet/Dry |
| Part No     | 263611 | 263813  | 26381251 | 265005  |
| Width       | 285mm  | 400mm   | 440mm    | 440mm   |
| Fits Tube   | ●      | ●       | ●        | ●       |

### Spray Extraction Spares



|                  |                           |                       |
|------------------|---------------------------|-----------------------|
|                  | EP7 Spray Extraction Pump | Spray Extraction Tool |
| Part No          | 2671910                   | 263626                |
| Dimensions       | 55 x 125mm                | 110 x 280mm           |
| Fits Tool Sleeve |                           | ●                     |

### Antistatic Vac Hose & Accessories



|               |                            |          |          |                          |          |          |          |
|---------------|----------------------------|----------|----------|--------------------------|----------|----------|----------|
|               | Antistatic Vac Hose (x30m) |          |          | Swivelling Hose Coupling |          | Vac Tool |          |
| ∅             | 32mm                       | 38mm     | 50mm     | 38mm                     | 50mm     | 45mm     | 58mm     |
| Rating        | 10°Ω/m                     | 10°Ω/m   | 10°Ω/m   | 10°Ω/m                   | 10°Ω/m   | 10°Ω/m   | 10°Ω/m   |
| Part No       | 26364630                   | 26404630 | 26504630 | 26405201                 | 26505001 | 26401901 | 265020   |
| Fits Hose     |                            |          |          | 26404630                 | 26504630 |          |          |
| Fits Coupling |                            | 26405201 | 26505001 |                          |          | 26405201 | 26505001 |
| Length        | 30m                        | 30m      | 30m      |                          |          | 245mm    | 230mm    |

Wall Mounted Self Service Vac Boom



Fully stainless steel boom designed for use with self service vacuum machines. The vertical suction is ideal for these fixed installations. The boom can be mounted away from the cabinet on a suitable wall, which allows for greater flexibility. The built in spring arm reduces the risk of hose kinking, therefore prolonging the life of the hose.

|                 | Self Service Boom |
|-----------------|-------------------|
| Part No         | 109001500         |
| Overall Height  | 2320mm            |
| Tube Height     | 1500mm            |
| Internal Tube Ø | 65mm              |

Vac Hose & Accessories for the Car Wash Industry



|                  | 38mm Blue Vac Hose | 38mm Hose Joiner | Swivelling 38mm Hose to Tool | 38mm Hose to Tool | 38mm Long Tool | 45mm Crevice Tool |
|------------------|--------------------|------------------|------------------------------|-------------------|----------------|-------------------|
| Part No          | 2640491            | 2640561          | 2640521                      | 2640524           | 2640192        | 264019            |
| Outlet           |                    |                  | 38/45mm                      | 38/45mm           |                |                   |
| Fits Hose        |                    | 2640491          | 2640491                      | 2640491           |                |                   |
| Fits Tool/Sleeve |                    |                  | ○ ▼                          | ○ ▼               | ◆              | ◆                 |





# CONSUMABLES

|                            |     |
|----------------------------|-----|
| Self Centring Bonded Seals | 146 |
| Hose Clips & Clamps        | 146 |
| Tools                      | 146 |
| O'Ring Sets                | 147 |
| Cable Ties                 | 147 |
| Compartment Boxes          | 147 |

Self Centring Bonded Seals



| To Fit Threads | Zinc Plated (Bag of 100 Seals) | Stainless Steel (Singles) |
|----------------|--------------------------------|---------------------------|
| 1/8"           |                                | DOW19                     |
| 1/4"           | DOW06100                       | DOW01                     |
| 3/8"           | DOW07100                       | DOW02                     |
| 1/2"           | DOW08100                       | DOW03                     |
| 3/4"           | DOW09100                       | DOW04                     |
| 1"             | DOW10100                       | DOW05                     |

Hose Clips & Clamps



|         | Z.P Twin Ear 'O' Clips |                 | Single Ear 'O' Clips |
|---------|------------------------|-----------------|----------------------|
|         | Z.P Steel              | Stainless Steel | Stainless Steel      |
| 9-11mm  | GS9-11                 |                 | SE0911SS             |
| 11-13mm | GS11-13                | GS11-13ss       | SE1113SS             |
| 13-15mm | GS13-15                | GS13-15ss       | SE1315SS             |
| 15-18mm | GS15-18                | GS15-18ss       | SE1518SS             |
| 17-20mm | GS17-20                | GS17-20ss       | SE1720SS             |
| 20-23mm | GS20-23                | GS20-23ss       | SE2023SS             |
| 22-25mm | GS22-25                | GS22-25ss       |                      |
| 23-27mm | GS23-27                |                 |                      |
| 25-28mm | GS25-28                |                 |                      |
| 28-31mm |                        | GS28-31ss       |                      |

|         | Mini Clips | Hose Clamps     |
|---------|------------|-----------------|
|         | Z.P Steel  | Stainless Steel |
| 10-12mm | GSMC1012   |                 |
| 11-13mm | GSMC1113   |                 |
| 12-14mm | GSMC1214   |                 |
| 8-12mm  |            | 73510           |
| 10-16mm |            | 73520           |
| 12-20mm |            | 73530           |
| 16-25mm |            | 73540           |
| 20-32mm |            | 73550           |
| 25-40mm |            | 73560           |
| 32-50mm |            | 73570           |
| 50-70mm |            | 73580           |

Workbench Essentials



| Hose Scissors |       |
|---------------|-------|
| Scissors      | 95500 |
| Spare Blade   | 95501 |



| O Clip Pliers |       |
|---------------|-------|
| Front Pinch   | GSOCP |



| Allen keys     |        |
|----------------|--------|
| 7mm (ST40)     | TPAK07 |
| 14mm (QRC Gun) | TPAK14 |

**'O' Ring Kits**



| Metric 'O' Ring Box | Imperial 'O' Ring Box |
|---------------------|-----------------------|
| GS030               | GS031                 |

**Cable Ties**



| All supplied in packs of 100 |        |            |
|------------------------------|--------|------------|
| Size                         | Colour | Part No    |
| 100 x 2.5mm                  | Black  | GSCT100-25 |
| 200 x 3.6mm                  | Black  | GSCT200-36 |
| 200 x 4.8mm                  | Black  | GSCT200-48 |
| 300 x 4.8mm                  | Black  | GSCT300-48 |
| 430 x 7.6mm                  | Black  | GSCT430-76 |
| 610 x 7.6mm                  | Black  | GSCT610-76 |
| 610 x 9.0mm                  | Black  | GSCT610-90 |

**Compartment Boxes**



| Compartment Boxes |                    |         |
|-------------------|--------------------|---------|
| Size (L x W x H)  | No of Compartments | Part No |
| 142 x 185 x 42    | 8                  | GSMCB   |
| 275 x 180 x 42    | 18                 | GSLCB   |

**Threaded Bolts**



| Thread & Length | Allen Bolt | Z.P Hex Bolt | SS Hex Bolt |
|-----------------|------------|--------------|-------------|
| M6 x 20mm       | IS1        |              |             |
| M6 x 25mm       | IS2        |              |             |
| M6 x 30mm       | IS3        | AS1          | AS1SS       |
| M6 x 35mm       | IS4        | AS2          | AS2SS       |
| M6 x 40mm       |            | AS3          | AS3SS       |
| M6 x 45mm       |            |              | AS4SS       |
| M6 x 60mm       |            |              | AS5SS       |
| M10 x 20mm      |            | GSM10X20SS   |             |



industry  
20000



industry





# INFORMATION

|   |            |
|---|------------|
| <b>Contact Information</b>                          | <b>150</b> |
| <b>Website Information</b>                          | <b>151</b> |
| <b>Technical Information</b>                        | <b>152</b> |
| <b>Returns Info, Delivery &amp; Invoice Queries</b> | <b>153</b> |

PENRITH

J40

A66

M6

West Coast Mainline

Contact Details



Unit 4, Gatebeck  
Farm, Gatebeck,  
Kendal, LA8 0HW



01539 566193



[sales@flowjet.co.uk](mailto:sales@flowjet.co.uk)



[www.flowjet.co.uk](http://www.flowjet.co.uk)

[www.flowjet.co.uk](http://www.flowjet.co.uk)

Nozzle Sizing Calculation

$$\text{Nozzle Size} = \sqrt{\frac{20}{\text{Working Pressure (bar)}} \times \text{Flow (lpm)}}$$

Or on a scientific calculator



DN6 Sewer Hose Pressure Drop Chart

Flow Rate

|            | 10 lpm | 15 lpm | 20 lpm | 25 lpm | 30 lpm | 35 lpm | 40 lpm | 45 lpm | 50lpm | 55 lpm | 60 lpm |
|------------|--------|--------|--------|--------|--------|--------|--------|--------|-------|--------|--------|
| <b>10m</b> | 1      | 2      | 4      | 7      | 8      | 12     | 15     | 18     | 22    | 27     | 33     |
| <b>15m</b> | 1.5    | 3      | 6      | 9      | 12     | 17     | 22     | 27     | 33    | 40     | 48     |
| <b>20m</b> | 2      | 4      | 7      | 12     | 16     | 22     | 28     | 36     | 44    | 53     | 63     |
| <b>25m</b> | 2.5    | 5      | 9      | 14     | 20     | 27     | 35     | 44     | 55    | 66     | 79     |
| <b>30m</b> | 3      | 6      | 10     | 17     | 24     | 32     | 42     | 53     | 65    | 80     | -      |
| <b>40m</b> | 3.5    | 7      | 13     | 22     | 32     | 42     | 55     | 70     | -     | -      | -      |
| <b>50m</b> | 4      | 8      | 17     | 27     | 38     | 53     | 68     | -      | -     | -      | -      |
| <b>60m</b> | 5      | 10     | 20     | 32     | 46     | 63     | -      | -      | -     | -      | -      |

Hose Length

Pressure drop in bar

Spray Angles & Coverage

The table below shows the theoretical coverage based on the spray angle and distance from the subject to be cleaned. The values are based on the assumption that the spray angle remains the same throughout the spray distance. In actual practice, the spray angle does not hold for longer spray distances. All measurements are in centimetres and are based on standard flat fan nozzles

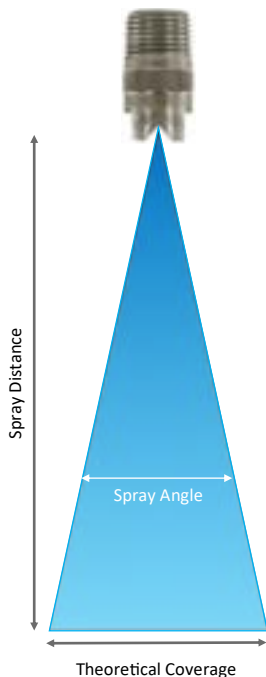

Distance from object

| Angle       | 10cm | 15cm | 20cm | 25cm | 30cm | 40cm | 50cm | 60cm | 80cm | 100cm |
|-------------|------|------|------|------|------|------|------|------|------|-------|
| <b>5°</b>   | 0.9  | 1.3  | 1.8  | 2.2  | 2.6  | 3.5  | 4.4  | 5.2  | 7.0  | 8.7   |
| <b>15°</b>  | 2.6  | 4    | 5.3  | 6.6  | 7.9  | 10.5 | 13.2 | 15.8 | 21.1 | 26.3  |
| <b>25°</b>  | 4.4  | 6.7  | 8.9  | 11.1 | 13.3 | 17.7 | 22.2 | 26.6 | 35.5 | 44.3  |
| <b>40°</b>  | 7.3  | 10.9 | 14.6 | 18.2 | 21.8 | 29.1 | 36.4 | 43.7 | 58.2 | 72.8  |
| <b>65°</b>  | 12.7 | 19.1 | 25.5 | 31.9 | 38.2 | 51.0 | 63.7 | 76.5 | 102  | 127   |
| <b>80°</b>  | 16.8 | 25.2 | 33.6 | 42.0 | 50.4 | 67.1 | 83.9 | 101  | 134  | 168   |
| <b>110°</b> | 28.6 | 42.9 | 57.1 | 71.4 | 85.7 | 114  | 143  | 171  | 229  | 286   |

Coverage (cm)



**RETURNS & WARRANTY INFO**

We hope you will be pleased with your purchase. Should you wish to return anything bought from us, we will be happy to offer a refund for the product, providing:

- All unwanted goods returned for credit must be unused, in it's original packaging and be in perfect condition.
- A completed returns form has been included with the return. Returns forms can be found in the Help & Advice section of our website, or call one of our team in the office for a copy.
- All goods must have been purchased from Flowjet Ltd within 90 days of the return date.
- All goods being returned due to being unwanted, cancelled order, incorrectly ordered and possible warranty claim, must be done at the customers expense.
- Items will only be collected if we sent the incorrect goods originally.
- If within a period of delivery, the purchaser gives notice that the product is defective, which has arisen under proper use, from faulty materials or workmanship, then G & S Penrith Ltd will with all possible speed replace the goods.
- We do not offer a repair or refurbish service. Any items returned to us for evaluation, will be inspected and reported on accordingly.

**DELIVERY & INVOICE QUERIES**

- All non deliveries and damage or shortages to any delivery must be reported within 3 days from the due date of the delivery.
- All invoice queries should be raised no later than 7 days from date of the invoice.
- Prices quoted will always exclude VAT, duty & carriage.
- All orders will be sent in the safest and most economical way, unless instructed otherwise.
- Carriage charges are calculated once the order has been picked and packed. Carriage charges include the cost of the packing materials and any costs incurred by G & S Penrith Ltd imposed by the parcel companies.





G&S

Services  
Cash Counter  
Returns  
Printing



